

Instructions for use of Diplomat dental units

MODEL PRO 500
MODEL PRO 600
MODEL PRO 700
MODEL PRO 800

Date: 25/03/2021
Revision: 1.1

 **DIPLOMAT
DENTAL
SOLUTIONS**

CONTENTS

1 Product information	7
1.1 Product description	8
1.2 Technical data	10
1.3 Used symbols	11
1.4 Location of labels	12
2 Main parts of the dental unit	13
2.1 Carried dental units	14
2.2 Stationary dental units	15
3 Product installation and assembly	17
3.1 Installation requirements	18
3.1.1 Electrical requirements	20
3.1.2 Operational requirements	20
3.2 Installation and assembly	21
3.3 Putting the unit into operation	22
3.4 Charging the tablet	22
4 Working with the tablet	23
4.1 Installing the Diplomat Connect application	24
4.2 Users	25
4.2.1 Creating a new user account	26
4.2.2 Adding a user to the list / Logging into an existing account	26
4.2.3 User log out	27
4.2.4 Deleting a user from the list	27
4.3 Connecting the tablet to the dental unit	28
5 Controlling the dental unit via the application	29
5.1 Basic screen	30
5.1.1 Control of basic functions	31
5.2 Quick settings	32
5.3 User settings	33
5.3.1 Setting the foot control	33
5.3.2 Setting the sound	34
5.3.3 Setting the lamp	34
5.3.4 Setting the bowl	35
5.3.5 Setting of the cup	36
5.3.6 Setting the heating of the instrument cooling water	36
5.4 Chair control	37
5.4.1 Program positions of the chair	37
5.5 Control of instruments	38
5.5.1 Standard TURBINE and proportionally controlled TURBINE	39
5.5.2 Micro-motor DX, DX BLUE	40
5.5.3 Micro-motor DX PRO, DX PRO BLUE	41

5.5.4	Micro-motor DX SRG	43
5.5.5	Ultra-sound scaler – SATELEC NEWTRON LED, SATELEC XINETIC	44
5.5.6	Ultra-sound scaler – LM PRO POWER	45
5.5.7	Ultra-sound scaler – EMS, DMETEC, WOODPECKER	46
5.5.8	Ultra-sound scaler – NSK	47
5.6	Instrument programs	48
5.3.7	Setting the foot control	48
6	Dental unit operation	51
6.1	Manipulation with the doctor's element for easier manipulation with the doctor's element, the pantographic arm is equipped with:	52
6.2	Whip lock	53
6.3	Foot control	54
6.3.2	Charging the battery of the wireless foot control	55
6.4	Cuspidor	55
6.4.1	Filling-up the distilled water	55
6.4.2	Filling-up and change of solutions for the automatic hygiene system	56
6.4.3	Central water supply	57
6.5	Assistant's table	58
6.5.1	Assistant's table with keyboard	58
6.5.2	Assistant's table without a keyboard	59
6.5	Assistant's table equipment	59
6.6	Lamp	60
6.6.1	Xenos lamp	60
6.6.1.1	Technical data	60
6.6.2	Faro Maia LED lamp	60
6.6.2.1	Technical data	60
6.6.3	Lamp control	61
6.7	Chair	62
6.7.1	Chair control	62
6.7.2	Head-rest control	62
6.8	Hand-rest	64
6.9	Converting the dental unit	65
6.10	Completion of the work with the dental unit	69
6.11	Safety sensors	70
6.11.1	Carried dental units	70
6.11.2	Stationary dental units	71
7	Product maintenance - cleaning, disinfection and decontamination	73
7.1	Disinfection of the instrument cooling waterways - Manual hygiene	74
7.1.1	Daily disinfection	74
7.1.2	Intensive disinfection of the instrument waterways	74
7.2	Disinfection of instrument cooling waterways - Automatic hygiene	75
7.2.1	Hygiene at the beginning of the working day	76
7.2.2	Hygiene after the procedure	77

7.2.3	Hygiene at the end of the working day	78
7.2.4	Intensive hygiene	79
7.3	Disinfection of instrument cooling waterways - Semi-automatic hygiene	82
7.3.1	Flushing	82
7.3.2	Semi-automatic hygiene	84
7.4	Cleaning and decontamination of dental unit components	86
7.4.1	Cleaning and decontamination of the saliva ejector	86
7.4.2	Cleaning and decontamination of big and small suction hoses	86
7.4.2.1	Maintenance, cleaning and decontamination of the CATTANI mini-separator	87
7.4.2.2	Cleaning and decontamination of the METASYS MST1 amalgam separator	88
7.4.2.3	Cleaning and decontamination of the DÜRR CAS1 amalgam separator and the DÜRR CS1 separator	88
7.4.3	Cleaning the big and small suction hose sieves	89
7.4.5	Cleaning and decontamination of the spittoon bowl	90
7.4.9	Cleaning, disinfection and decontamination of other parts of the dental unit	91
7.4.10	Instruments and nozzles	91
8	Warranty, service and disposal of goods	93
8.1	Service	94
8.1.1	Service inspections during the warranty period	94
8.1.2	Service inspections after the warranty period	94
8.2	Electrical safety inspection	94
8.3	Warranty	94
8.4	Disposal of the device	94
9	Packaging content, packing and transport	97
9.1	Packaging content	98
9.2	Transport conditions	98
9.3	Storage conditions	98
10	Electromagnetic compatibility requirements according to EN 60601-1-2	99
10.1	Electromagnetic radiation	100
10.2	Electromagnetic resistance	100
10.3	Recommended safety distances between portable high-frequency communication devices and the dental unit	103



1 Product information

This instructions for use describes how to use the Diplomat dental unit **MODEL PRO 500 MODEL PRO 600, MODEL PRO 700, MODEL PRO 800**

Please read this instructions before first use.

Purpose of use of the dental unit:

The dental unit is used to support and position the patient and to supply the necessary inlets for instruments and for dental treatment of the patient by a trained dentist. A dental unit is a device consisting of a system of structural units, equipment and instruments that form a functional unit for dental treatment.

Use of the unit is only permitted for a trained dentist who has read these instructions for use in detail. Installation, setting and any modifications must be performed by a qualified authorized service technician who is authorized to perform this activity. Conditions for the media used and installation specified in these **instructions for use** must also be met.

1.1 Product description

Diplomat MODEL PRO 500 and MODEL PRO 700 are dental units carried by a chair. MODEL PRO 600 and MODEL PRO 800 are stationary dental units with an integrated chair. All models of dental units consist of the same functional parts. From the patient chair, the spittoon block, the doctor's table arm with the doctor's table, the lamp arm with the lamp and the assistant's arm with the assistant's table. The instruments on the doctor's table or other functions of the dental unit are controlled by means of a foot control. The function of the control panel of the doctor's table is provided by a touch tablet. All functions of the dental unit can be controlled via a tablet application. The spittoon block can be equipped with different types of suction systems, different types of separators and amalgam separators. The dental unit can be equipped with a system of waterway hygiene of instruments and suction with various degrees of automation.

Optional equipment on the lamp arm post can be a monitor arm with a monitor and an additional arm with a storage tray.

Product	Leading of instrument hoses	Number of instruments	Assembly
MODEL PRO 500	upper lower	5	carried
MODEL PRO 600	upper lower	5	Lifting
MODEL PRO 700	upper lower	6	carried
MODEL PRO 800	upper lower	6	Lifting

Instrument equipment

- Syringe.
- Rotary instruments:
 - Turbine (max. 3)
 - BLDC micro-motor (max. 3)
 - Surgical micro-motor (max. 1)
- Ultrasonic scaler
- Polymerizing lamp

Parts of the unit in contact with the patient:

- Chair seat
- Back-rest
- Head-rest
- Hand-rest
- Instruments

*i. All instruments except for the polymerizing lamp can be equipped with light
i. Optional equipment and additional equipment (see valid price list)*

Indications, contraindications of a medical device:

Indications: The dental unit is intended for the prevention, treatment or alleviation of a disease in the patient's oral cavity.

Contraindications: not known

Patient profile:

- Age: adult population, children older than about 3 years
- Weight: up to a maximum patient weight of 200 kg
- Medical Condition
during the examination, the dentist will determine the suitability of the treatment and rule out the occurrence of contraindications for the patient
- Nationality: not determining

Body part or tissue type: patient's oral cavity



Do not use the medical device if it is suspected of being damaged or malfunctioning.
Contact an authorized service technician.













1.2 Technical data

Dental unit	Value
Supply voltage	220 - 240 V ~ 100 - 127 V ~ 24 V AC \pm 10% * (MODEL PRO 500, 700)
Frequency	50/60 Hz
Max. input	400 VA / 1900 VA (MODEL PRO 600, 800)
Inlet air pressure	0.45 - 0.8 MPa
Inlet water pressure	0.3 - 0.6 MPa
Net weight of the unit (MODEL PRO 500, 700)	130 + max. 50 kg
Gross weight of the unit (MODEL PRO 500, 700)	180 + max. 50 kg
Type of protection against electric shock	Protection class I instrument
Degree of protection against electric shock	Type B attaching parts
Degree of protection by cover	IP21
Water temperature for the cup (if a boiler is fitted)	25 - 35 °C
Load capacity of the storage table on the lamp arm	1.5 kg
Load capacity of the doctor's panel tray table:	1.5 kg

Chair	Value
Seat height range above the ground:	
<ul style="list-style-type: none"> MODEL PRO 500, MODEL PRO 700 With cradle function / without cradle function 	380 mm - 815 mm \pm 20 mm
<ul style="list-style-type: none"> MODEL PRO 600, MODEL PRO 800 with cradle function / without cradle function 	350 mm - 820 mm \pm 20 mm
Cradle function range of the back-rest from the vertical plane:	
<ul style="list-style-type: none"> with cradle function 	30° \pm 2° to 96° \pm 2°
<ul style="list-style-type: none"> without cradle function 	36° \pm 2° to 94° \pm 2°
The seat cradle function from a horizontal plane in the version without cradle function	26° \pm 2°
The seat cradle function range from a horizontal plane: in the version with cradle function	20° \pm 2° to 28° \pm 2°
Vertical movement in the unloaded state	max. 19 s
Movement of the back-rest in the unloaded state	max. 13 s
Chair load capacity (EN ISO 7494-1)	max. 200 kg
Weight of the chair according to the design	not applicable for (MODEL PRO 600, 800)
<ul style="list-style-type: none"> Anchored without seat cradle function 	118 + max. 5 kg
<ul style="list-style-type: none"> Anchored with seat cradle function 	122 + max. 5 kg
<ul style="list-style-type: none"> Not anchored without seat cradle function 	133 + max. 5 kg
<ul style="list-style-type: none"> Not anchored with seat cradle function 	137 + max. 5 kg
Weight of the chair brutto (MODEL PRO 500, 700)	160 + max. 25 kg
Operating mode	1:16
Chair noise	max. 54 dB

* In case of use of external power supply 24 V AC, this power supply must meet the requirements for medical devices

1.3 Used symbols

Symbol	Description	Symbol	Description
	Warning, Notice, Caution		Type B attaching part
	Note	IP21	Degree of protection against water ingress
	Serial no.		CE marking - the product meets EU legislative requirements
	See instructions for use		Sterilizable in a steam sterilizer (autoclave) at 135 ° C
	Manufacturing Date		The device is a hazardous waste - hand it over in a collection point
	Manufacturer		Protection class II equipment
	Follow the Instructions for use		

1.4 Location of labels

Label description:

1. Marking of the unit production
2. Basic electrical parameters
3. Serial number
4. Manufacturing date
5. Chair operation mode

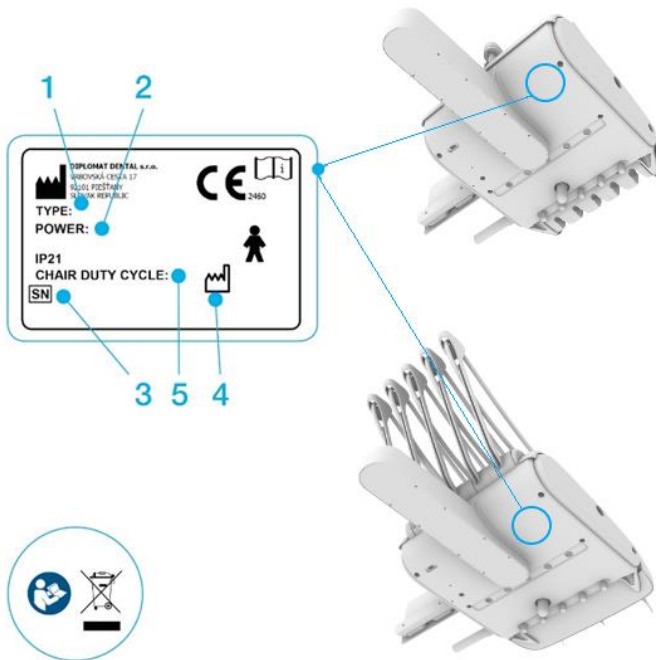

2 Main parts of the dental unit

2.1 Carried dental units

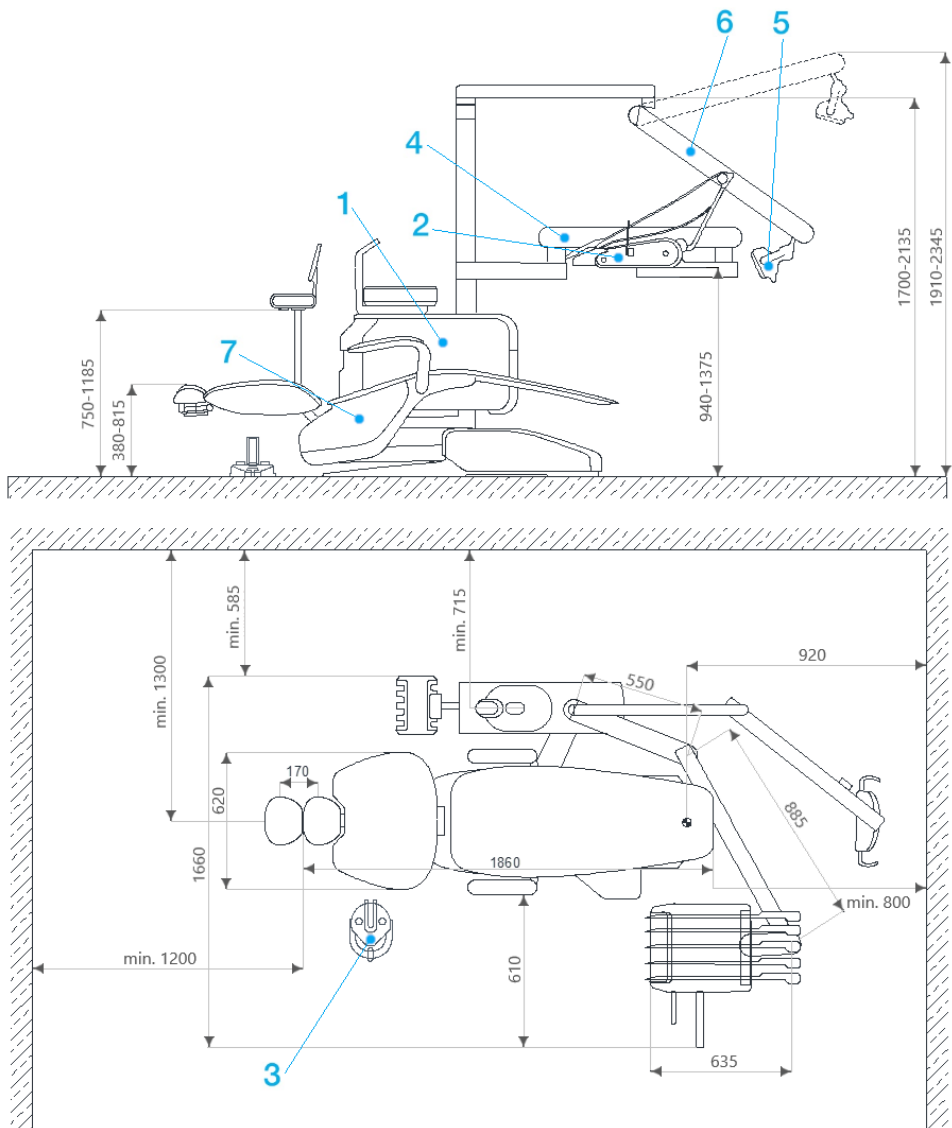

1. Cuspidor with sister' arm
2. Control panel
3. Foot control
4. Control panel pantograph

5. Dental light
6. Light pantograph
7. Dental chair

2.2 Stationary dental units

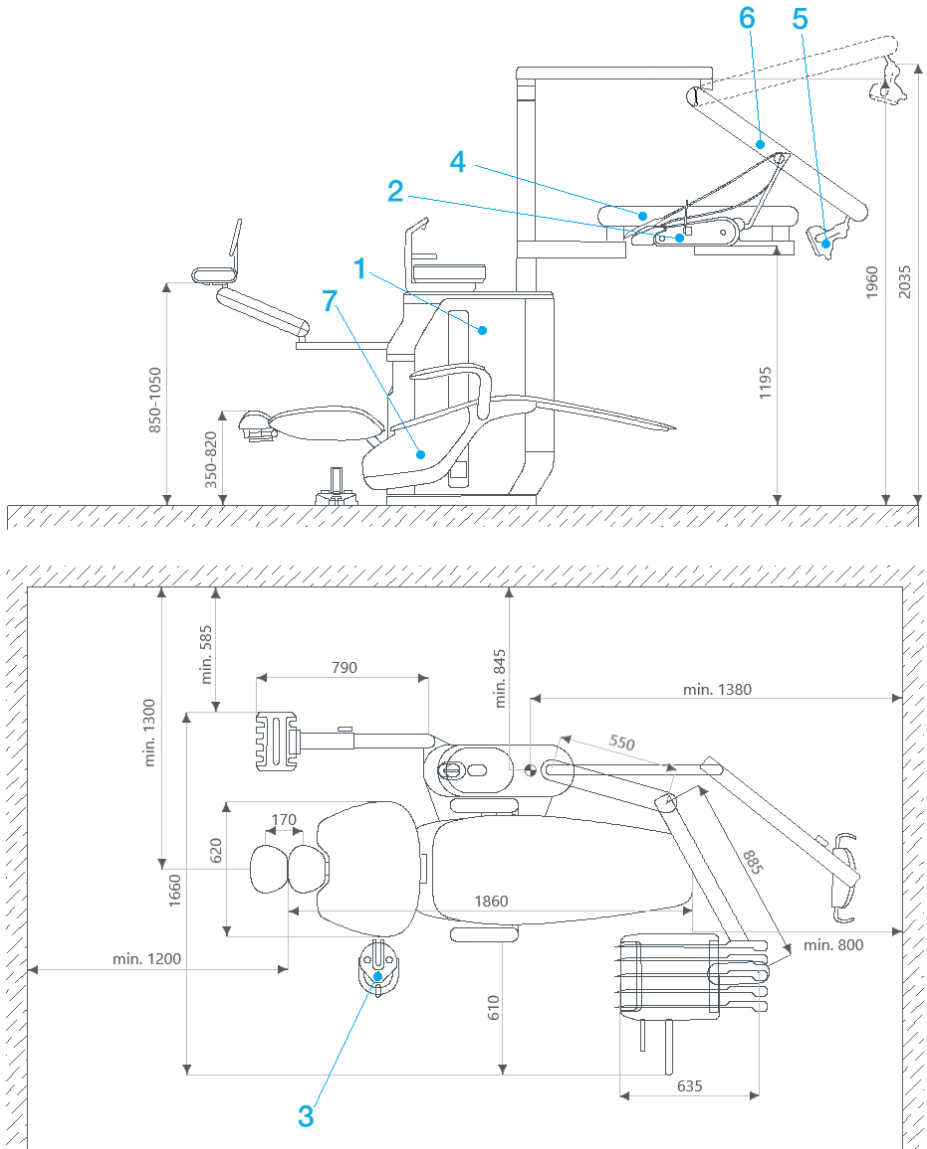

- | | |
|-------------------------------|---------------------|
| 1. Cuspidor with sister's arm | 5. Dental light |
| 2. Control panel | 6. Light pantograph |
| 3. Foot control | 7. Dental chair |
| 4. Control panel pantograph | |

3 Product installation and assembly



Pre-installation and installation must be carried out in accordance with the applicable national standards and in accordance with the manufacturer's valid documentation.
 To reduce the risk of electric shock, this equipment must be connected to a mains supply with a protective earthing.
 Do not install in potentially explosive premises!
 Do not modify this apparatus without the manufacturer's authorization!

3.1 Installation requirements

Floor	Concrete slab \geq 100 mm. Slope \leq 1%. Antistatic flooring is preferred.												
Water	<p>Drinking water from the central supply:</p> <table> <tr> <td>Inlet pressure</td> <td>0.3 MPa to 0.6 MPa</td> </tr> <tr> <td>flow</td> <td>> 5 l/min</td> </tr> <tr> <td>particles</td> <td>smaller than 50 μm</td> </tr> <tr> <td>Water hardness</td> <td>< 2.14 mmol/l</td> </tr> <tr> <td>pH</td> <td>6.5 – 8.5</td> </tr> <tr> <td>max. electrical conductivity</td> <td>2000 μS/cm</td> </tr> </table> <p><i>i. If the water contains particles bigger than 50 μm, a 50 μm filter must be pre-wired. Water must comply with local drinking water regulations. We recommend CU pipes, or PE respectively.</i></p>	Inlet pressure	0.3 MPa to 0.6 MPa	flow	> 5 l/min	particles	smaller than 50 μ m	Water hardness	< 2.14 mmol/l	pH	6.5 – 8.5	max. electrical conductivity	2000 μ S/cm
Inlet pressure	0.3 MPa to 0.6 MPa												
flow	> 5 l/min												
particles	smaller than 50 μ m												
Water hardness	< 2.14 mmol/l												
pH	6.5 – 8.5												
max. electrical conductivity	2000 μ S/cm												

Cooling of instruments with the central water supply

In the central water supply, a shut-off valve and a valve are included for the unit to prevent water back-flow.

Requirements and recommendations

- If water from a central supply is used to cool the instruments, it is necessary to have a particulate filter upstream at the water inlet
- 5 μ m
- If water contains more than **50 mg CaO/l** or **36 mg MgO/l**, a water hardness treatment device must be included and connected to the water inlet. Hard water can cause malfunction of the unit. The water hardness treatment device is pre-fixed when distilled water is not used.
- When required to install a connection point for inlet water sampling, the following diagram shows the recommended location of the connection point for inlet water sampling.

These devices are not a part of the dental unit.

Wiring diagram of the input elements of the dental unit (EN ISO 7494-2)

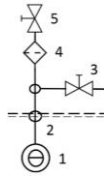

- 1 - inlet water from an external drinking water supply
- 2 - inlet water connection point
- 3 - connection point for inlet water sampling
- 4 - water particle filter
- 5 - manual inlet valve

Pressed air

Compressed air must be oil-free, clean and dry:

inlet pressure 0.45 to 0.8 MPa
flow > 55 l/min

Recommended values:

dew point max. -20°C
oil max. 0.5 mg/m³
particles 1-5 µm max. 100/ m³

Suction (in the case of a spittoon block with big and small suction hoses)

The static vacuum must be in the range of min. 0.005 MPa (50 mbar) to max. 0.02 MPa (200 mbar) measured at the installed position. If the static vacuum is higher than 0.02 MPa, it is necessary to connect a suction calibration (regulating) valve to the suction branch, which will limit the max. vacuum to 0.02 MPa. This control valve is not a part of the dental unit. The suction unit must produce a flow of min. 450 Nl/min. Measured at the installed position.

Pressure loss between the connection point of the suction source of the dental unit and the atmospheric end of the cannula:

Flow [NL/min]	Vacuum [mbar]	
	Big suction hose	Small suction hose
90	57	53
150	67	62
200	79	74
250	110	91
300	130	100
350	170	120

Waste

The waste pipe must have a continuous slope of min. 1% with a minimum flow rate of 10 l / min. and must be free of sharp bends and conditions that could cause back-flow. Do not use the same waste branch with another dental unit or washbasin! It is permitted to use polypropylene or hardened polyethylene pipes.



If the regulations of the country in which the installation is performed require an amalgam separator, the dental unit without the amalgam separator must be connected to an external amalgam separator. The installation of the external amalgam separator must be carried out according to the instructions of its manufacturer.

3.1.1 Electrical requirements

Value of the recommended mains fuse

The recommended value of the power supply fuse is 16 A (in the case of using a circuit breaker - circuit breaker with tripping characteristic type C). No further clinical devices may be connected to the dental unit supply! The maximum electrical input of the dental unit is 1,900 VA. The supply must comply with the corresponding national standard.

Recommendation

Unless the national standard states otherwise, the manufacturer prescribes the use of a current protector with the sensitivity of 30 mA. After meeting the pre-installation requirements, the dental unit will be assembled and mounted and connected to the media.

Mutual interference

During its operation, the dental unit does not affect the operation of other electronic apparatuses in its vicinity.

3.1.2 Operational requirements

Parameter	Value
Ambient temperature	15 - 40 °C
Relative humidity	30 - 75 % non-condensing humidity
Atmospheric pressure	700 - 1060 MPa
Altitude	≤ 3000 m

3.2 Installation and assembly

i. The installation must be performed by a service technician with a valid certificate. Otherwise the warranty will not be recognized. Make out the registration form and send it to the manufacturer or dealer.

Unpacking and checking of the delivery

Integrity of the transport packaging is checked. If the transport container is damaged, do not open the shipment and report the error immediately to the carrier or the seller.

If the shipment is intact, carefully disassemble the packaging and unpack the individual parts of the unit. Check the completeness of the packing according to **packing sheet**.

The detailed installation and assembly procedure for the dental unit is not the subject of these instructions for use.

Minimum user interface requirements (tablet)

The manufacturer recommends tablets with the iOS operating system: iPad mini 4, iPad, iPad Air, iPad Pro 11" and higher.

When using a tablet with Android 6.0 and higher operating system, the requirements are as follows:

Processor:	Processor frequency	2 GHz
	Number of processor cores	4 ×
	Processor type	Snapdragon 660 and newer, Exynos 7904 and newer,
Memory:	Storage capacity	32 GB
	RAM size	3 GB (3 072 MB)
Display and resolution:	Display diagonal	8" - 10"
	Resolution	2560 × 1600
Interface:	Bluetooth®	4.2
	WiFi	WiFi 802.11ac, WiFi 802.11n, WiFi 802.11g, WiFi 802.11b, WiFi 802.11a

3.3 Putting the unit into operation



Disinfection of a new dental unit before its first use

Before putting the new unit into operation, the waterways of the instruments must be disinfected by a service technician, according to the instructions given in the Installation Manual.

Switch-on the unit:

When switching-on the unit, it is recommended to check whether the instruments are in their positions - in their holders, to have the foot control in the rest position and the keyboard keys not pressed.

- switch-on the compressor
- open the central water supply
- switch-on the suction unit
- switch-on the main power switch
- start the DIPLOMAT CONNECT application on the tablet and connect to the dental unit

When the beep sounds, the unit is ready for operation.

If the unit is equipped with water heating, it takes about 10 minutes to heat the water to the unit temperature.

3.4 Charging the tablet

The tablet can be charged using the charger built into the dental unit. The USB connector for connecting the cable is located on the bottom of the doctor's element.



4 Working with the tablet

4.1 Installing the Diplomat Connect application

1. Activate WiFi on your tablet and make sure you're connected to the Internet.
2. Open the App Store® or Play Store® application and search for Diplomat Connect
3. Install the Diplomat Connect application

i. for help how to work with:

- iPad, see the instructions for use for the iPad ©
 - tablet with Android OS instructions for using the respective device
4. Activate Bluetooth®
 5. Activate GPS (only if required by Android)

i. The tablet communicates with the unit via the Bluetooth® interface. Some Android devices also require activation of the GPS module for communication via Bluetooth®.

Application start:

1. Open the Diplomat Connect



application

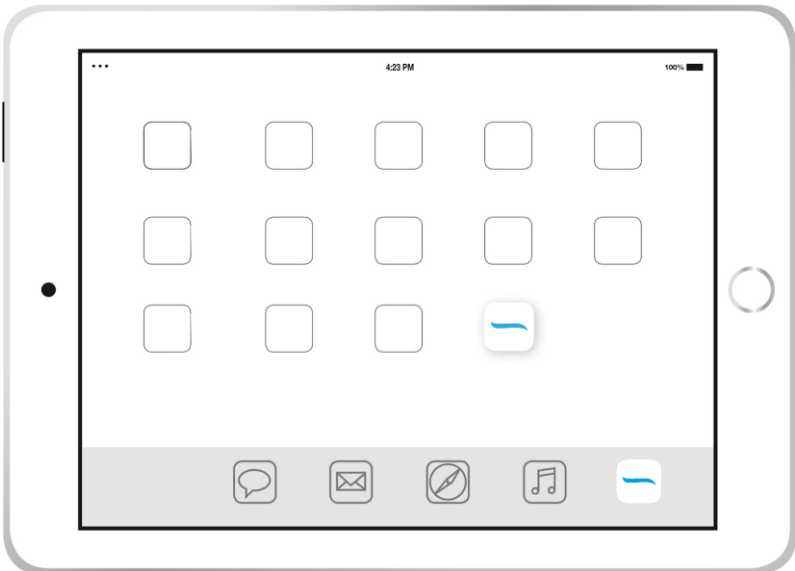

4.2 Users

The Users screen appears automatically when you start the application.

1. Press 1. to create a new user account.
2. Press 2. to continue working as a Guest user.

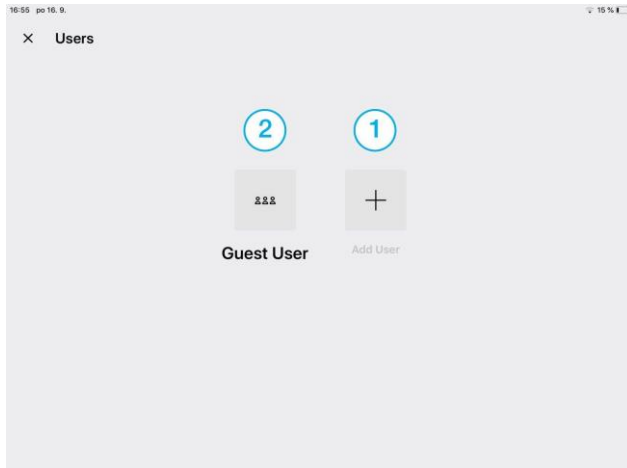

3. The Users screen can be displayed by pressing the current button User 1 (DEMO USER).

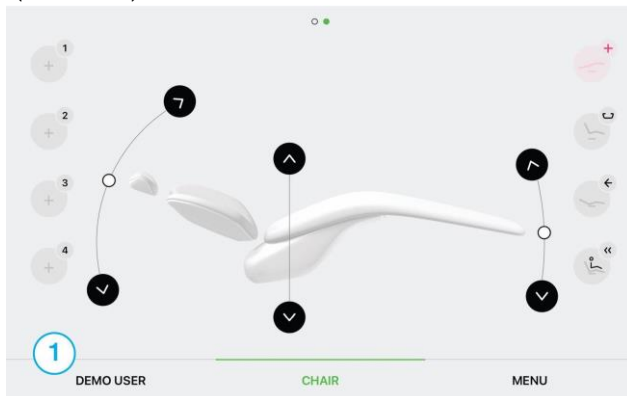

4.2.1 Creating a new user account

i. This procedure requires an Internet connection

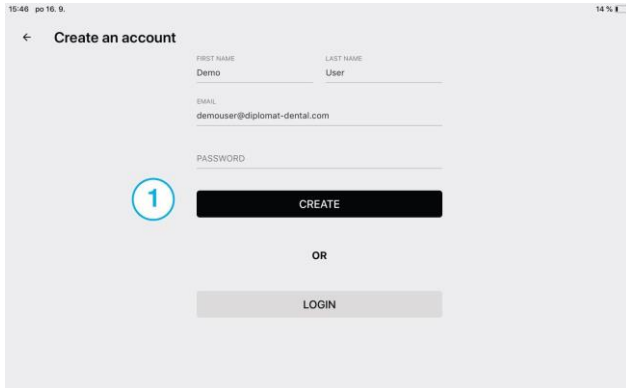

1. Fill in the blank fields
2. Press 1. CREATE

i. changing the user password is possible in the menu - user settings. See the chapter 5.3

4.2.2 Adding a user to the list / Logging into an existing account

i. This procedure requires an Internet connection

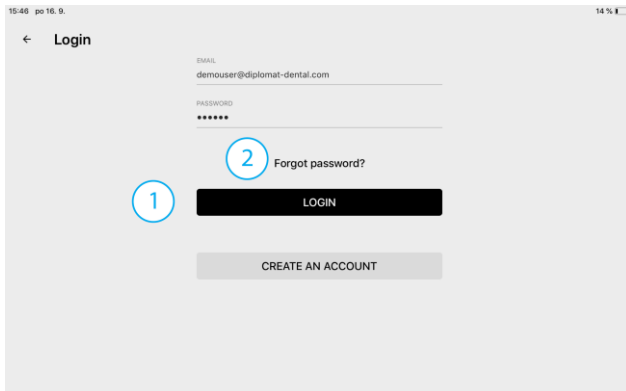

1. Fill in the blank fields
2. Press 1. LOG IN
3. Press 2. for the FORGOTTEN PASSWORD process and follow the instructions.

4.2.3 User log out

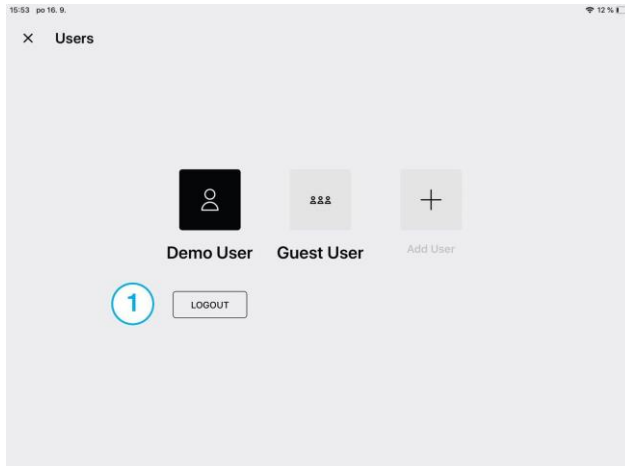

1. Press 1. LOG OUT

4.2.4 Deleting a user from the list

i. Unable to delete Guest type and currently logged in user

1. Press and hold the icon of the user you want to delete from the list
2. Cancel 1. or confirm 2. deleting the user from the list

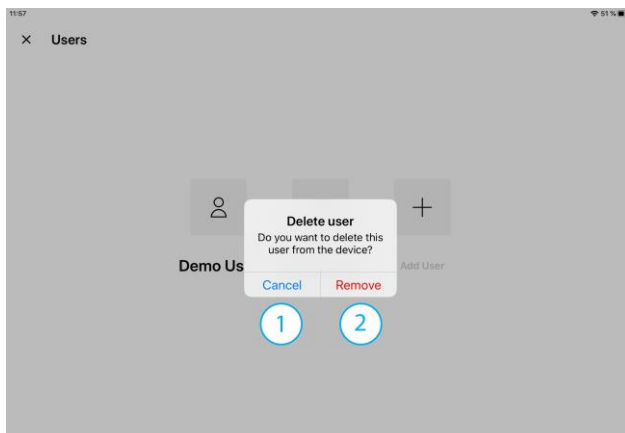

4.3 Connecting the tablet to the dental unit

After a successful user log in, the “Dental Unit Selection” screen will automatically appear
The “Dental Unit Selection” screen can be called up from the MENU

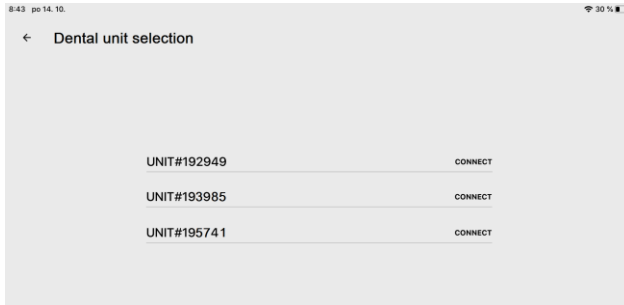

1. to connect to the dental unit, press the CONNECT button - the connected unit is highlighted in green
2. to disconnect the dental unit, press the DISCONNECT button
3. to rename the dental unit, press the RENAME button

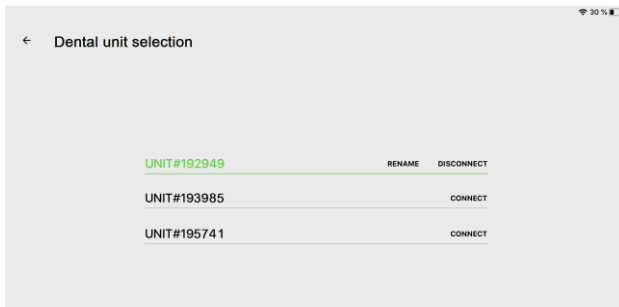

i. Only dental units that are not connected to any tablet are visible in the list of dental units.

If the dental unit you want to connect to is not available in the list, it is possible that:

1. The dental unit is switched-off - switch-on the unit!
2. The dental unit is connected to another tablet (Bluetooth® button is lit) - press the Bluetooth® button to disconnect the connected tablet (Bluetooth® button flashes).



5 Controlling the dental unit via the application

5.1 Basic screen

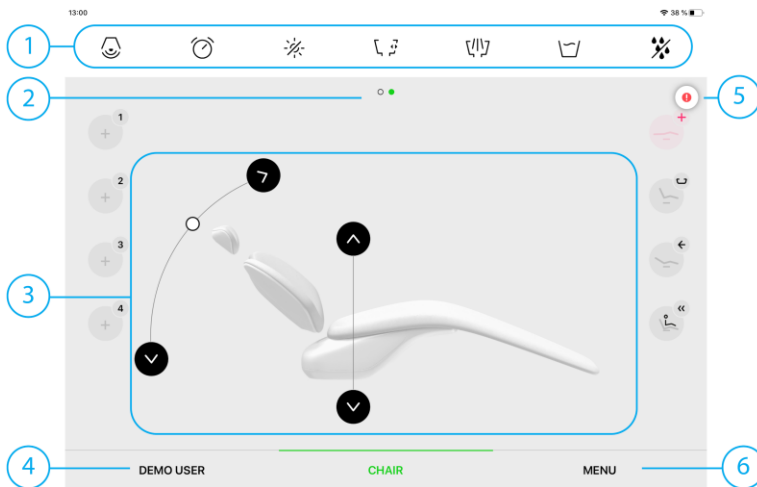

By logging in, the basic screen for operating the unit is displayed.

1. Control of basic functions
2. Identifier of the possibility of moving between two screens.
3. Controlling the chair
4. Users
5. Icon to display the notification
6. User MENU



The tablet is not connected
to the unit



The tablet is connecting
to the unit







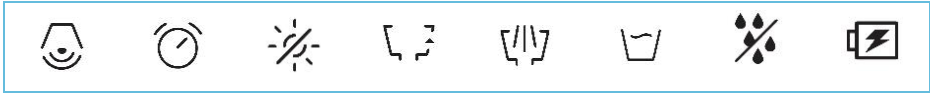







The tablet is connected
to the unit

5.1.1 Control of basic functions



Symbols used

Symbol	Description	Symbol	Description
	Bell - pressing the button activates the switching contact in the spittoon block		
	Timer - the timer is inactive Press the button to display the time Setting screen. Subsequent confirmation starts the countdown.		Timer - the timer counts down. After time countdown an audible signal sounds. By pressing the button, the countdown will stop.
	Lamp control - the lamp does not light. By pressing the button, the lamp lights up for the operating light.		Lamp control - the lamp illuminates at the intensity unit for the operating light. By pressing the button, the lamp dims. By long pressing and holding the lamp will switch-off.
			Lamp control - the lamp illuminates at the intensity unit for the dimmed light. By pressing the button, the lamp lights up to a higher intensity. By long pressing and holding the lamp will turn-off.
	Bowl rinsing - the bowl is not rinsing. By pressing the button, the rinsing is started. By long pressing and holding, the rinsing is programmed.		Bowl rinsing - the bowl is rinsing. By pressing the button, the rinsing is stopped.
	Turning the bowl - the bowl is retracted. By pressing the button, the bowl is ejected.		
	Turning the bowl - the bowl is ejected towards the patient. By pressing the button, the bowl will be parked.		Turning the bowl - the bowl is ejected or retracted.
	Filling the cup - the cup is not being filled. By pressing the button, the filling is started. By long pressing, the filling is programmed.		Filling the cup - the cup is being filled. By pressing the button, the filling is stopped.



Instrument cooling water source - no cooling water / distilled water bottle is de-pressurized



Instrument cooling water source - distilled water from a bottle



Instrument cooling water source - water from the central water supply

<p>Status of the foot control - charging</p>	<p>> 100%</p>	<p>60%</p>	<p>30%</p>	<p>Low battery, connect the foot control with a cable to the unit</p>
--	------------------	------------	------------	---

5.2 Quick settings

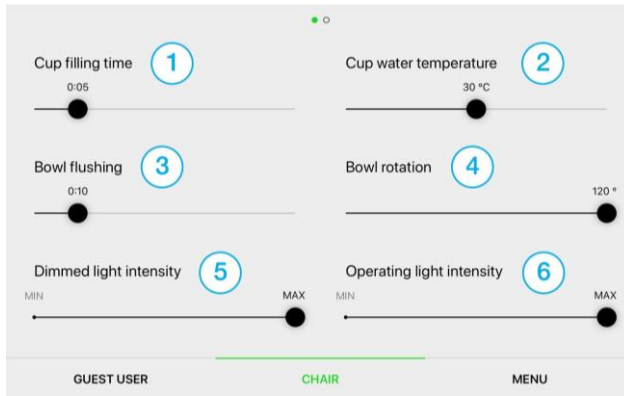

The screen is displayed by dragging finger on the screen to the right.

1. setting the cup filling time
2. water temperature setting for cup filling (only available with built-in water heater)
3. setting the bowl rinsing time
4. adjusting the bowl rotation angle (only available for electric bowl drive)
5. adjusting the intensity of dimmed light
6. adjusting the intensity of operating light

5.3 User settings

By pressing the MENU / USER SETTINGS, the following options will be displayed:

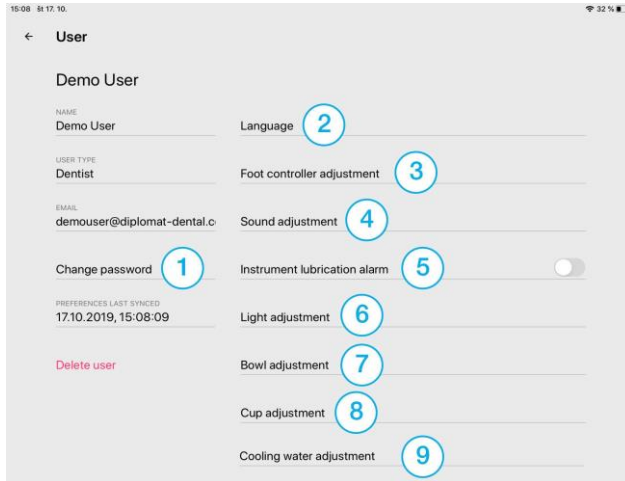

1. Change of the password
2. Setting the language
3. Setting the foot control
4. Setting the sound
5. Switch-on / off the alarm for instrument lubrication
6. Setting the light
7. Setting the bowl
8. Setting the cup
9. Setting the cooling water

5.3.1 Setting the foot control

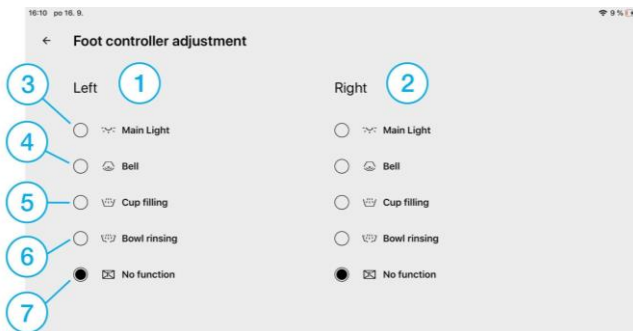

1. Assigning a function for the left button
2. Assigning a function for the right button
3. Operating light
4. Bell
5. Filling the cup
6. Rinsing the bowl
7. No function

5.3.2 Setting the sound



1. Switch-on / off the touch sound
2. Switch-on / off the notification sound
3. Setting the sound intensity

5.3.3 Setting the lamp

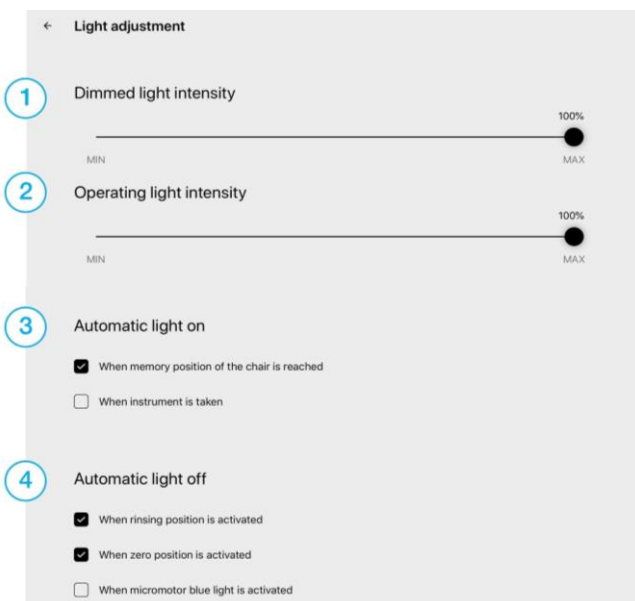

1. Dimmed light intensity
2. Operating light intensity
3. Automatic switch-on the light:
 - After reaching the memory position of the chair
 - After selecting an instrument
4. Automatic switch-off the light:
 - At the beginning of the movement to the rinsing position of the chair
 - At the beginning of the movement to the zero position of the chair
 - When the blue light of the instrument is switched on

5.3.4 Setting the bowl

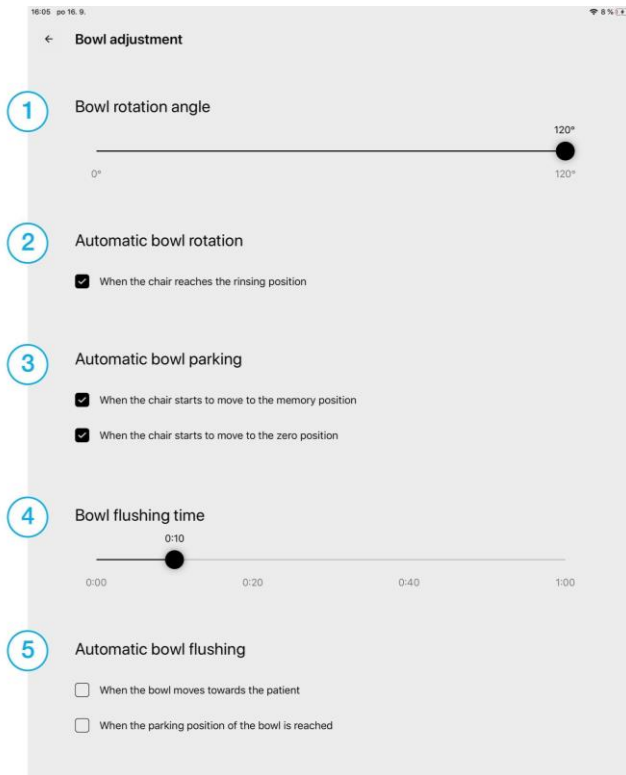

1. Setting the rotation angle of the bowl
2. Automatic bowl rotation:
 - After reaching the rinsing position of the chair
3. Automatic parking of the bowl:
 - At the beginning of the movement into the memory position of the chair
 - At the beginning of the movement to the sitting position of the chair
4. Setting the bowl rinsing time
5. Automatic rinsing of the bowl:
 - After turning the bowl to the patient
 - After reaching the parking position of the bowl

5.3.5 Setting of the cup

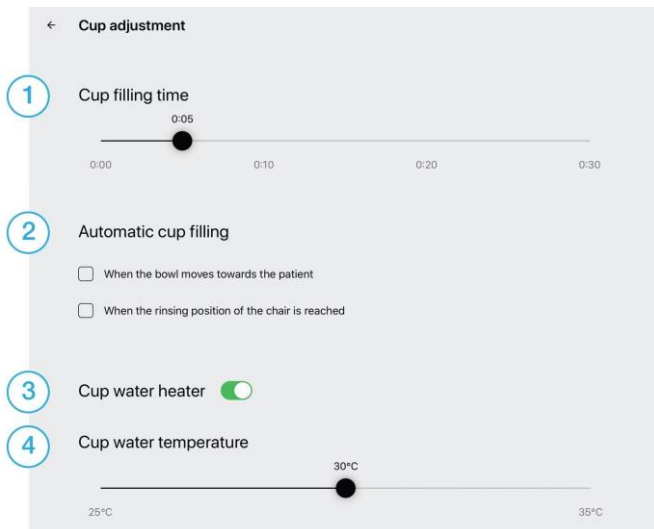

1. Setting the filling time of the cup
2. Automatic filling of the cup:
 - To rotate the bowl towards the patient
 - After reaching the rinsing position
3. Switch-on/off the heating of the cup filling water (only available if a water heater is installed)
4. Setting the water temperature for filling the cup (only available if a water heater is installed)

5.3.6 Setting the heating of the instrument cooling water

1. Switch-on/off the heating of instrument cooling water (only available if an instrument cooling water heater is installed)
2. Setting the temperature of heating the instrument cooling water

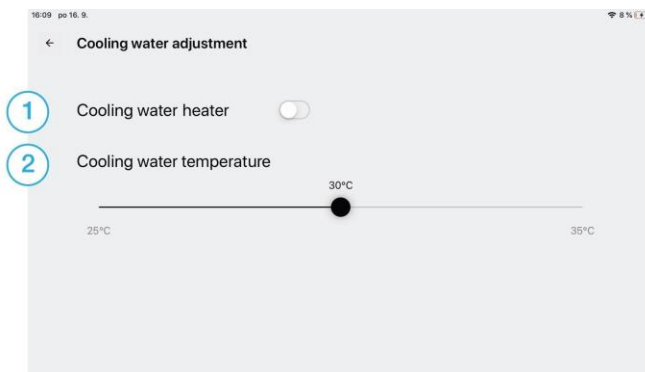

5.4 Chair control

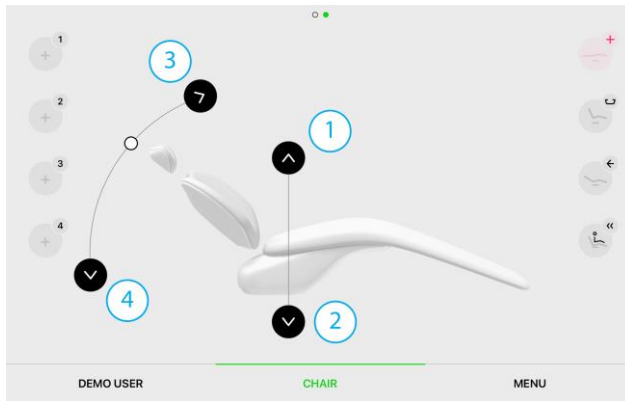

Setting the chair height and the back-rest position

- By pressing the button 1, the chair is moved upwards
- By pressing the button 2, the chair is moved upwards
- By pressing the button 3, the back-rest is moved upwards
- By pressing the button 4, the back-rest is moved downwards

i. Cradle functioning the chair is only available for a chair that is equipped with a mechanism for cradle functioning the chair when moving the back-rest.

5.4.1 Program positions of the chair

- i. The automatic movement of the chair can be stopped by pressing any button for controlling the chair*
- i. The Trendelenburg position of the chair cannot be changed.*

It is possible to program four different chair positions. It is also possible to program the mounting position and the flushing position of the chair.

The stored program is identified by the silhouette of the chair in the program position button.

















The + button means that no chair position is programmed.

Call up the program position of the chair

Pressing the button activates the movement of the chair to the programmed position.

Saving the program position of the chair

By long pressing and holding the button, current position of the chair is saved. Repeated long pressing and holding the button with an already programmed position, will overwrite the original position of the chair to current one.

	buttons in the state without programmed chair position
	buttons in the state with programmed chair position
	the chair moves to the programmed position
	the chair is in the programmed position
 Flushing position	 Previous Position (Last Position)
 The chair moves to the flushing position	 The chair moves to the previous position
 The chair in flushing position - return from the flushing position	 The chair is in the previous position
 Mounting position	 Trendelenburg chair position
 The chair moves to the mounting position	 The chair moves to the Trendelenburg position
 The chair in the mounting position	 The chair is in the Trendelenburg position

5.5 Control of instruments

All instruments on the doctor's table are active and can only be controlled after removing them from the holder (doctor's table with the lower line) or removing them from the doctor's table (table with the upper line). This automatically displays the individual instrument screens where their parameters can be unit. Starting (start) and subsequent regulation of the revolutions or power of the individual instruments is performed by means of the foot control lever.

i. Working with two instruments - while working with the instrument, it is possible to remove the second instrument from the doctor's table. The work of the active instrument is not limited in any way. Subsequent starting of an instrument other than the one currently being worked on is only possible after all instruments have been put back on the doctor's table.

5.5.1 Standard TURBINE and proportionally controlled TURBINE

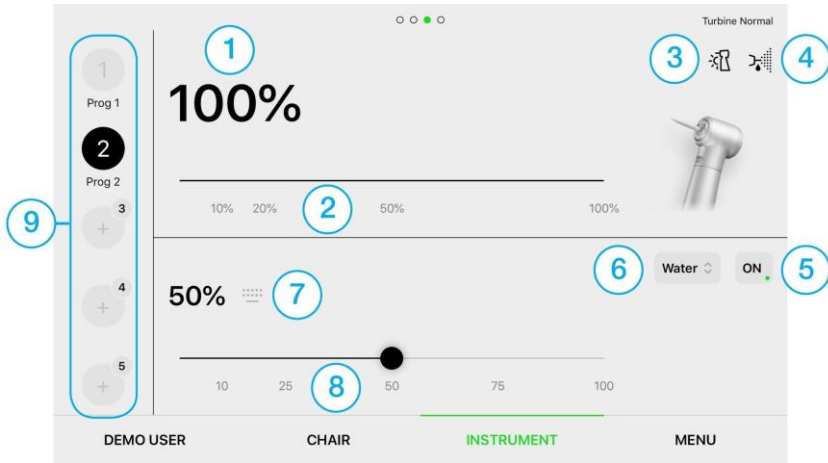

i. Points 1 and 2 are only available for a turbine with a proportional valve.

- Setting the maximum turbine revolutions.
By the Setting it is possible to limit the maximum instrument revolutions to the desired value.

- Quick selection of the pre-unit maximum turbine revolutions

- Lighting of the instrument:



Lighting on



Lighting off

Automatic instrument chip-blower.

- This function is active only when cooling is switched on. When switched on, the cooling air continues to run for 0.5 seconds after the instrument is stopped.



Chip-blower on



Chip-blower off

- Switch-on/off of the instrument cooling

- Changing the type of instrument cooling Possible Settings: air, water, spray

- Setting the quantity of instrument cooling water

- Quick pre-selection of Setting the quantity of the instrument cooling water

Program Panel.

- The dentist can save up to 10 different instrument Settings and then quickly recall them while working by pressing the appropriate program on the tablet or using the foot control. See chapter Instrument programs

5.5.2 Micro-motor DX, DX BLUE

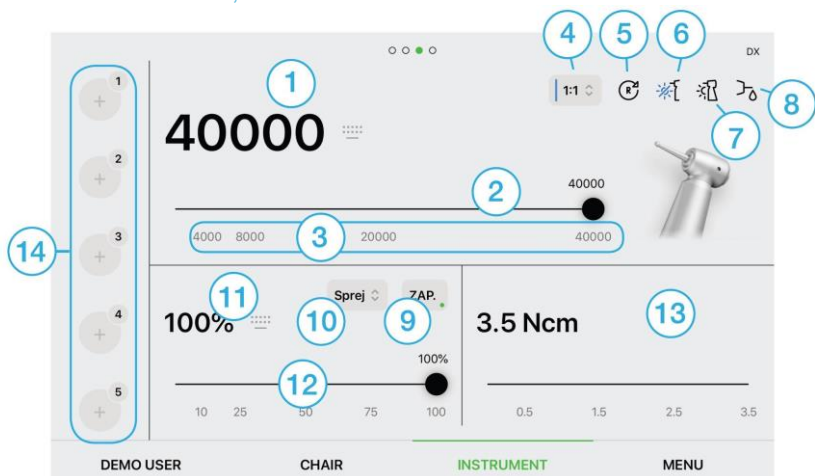

1. Direct Setting of the micro-motor revolutions using the keyboard
2. Setting the maximum micro-motor revolutions.
3. Buttons for the micro-motor revolutions quick selection
4. Nozzle gear ratio
5. Changing the direction of the micro-motor rotation - R to the right - L to the left
6. Instrument lighting - blue light (only available in DX BLUE version). Possible Settings:



Lighting on



Lighting off

7. Instrument lightning. Possible Settings:



Lighting on



Lighting off

Automatic instrument chip-blower.

8. This function is active only when cooling is switched on. When switched on, the cooling air continues to run for 0.5 seconds after the instrument is stopped. Possible Settings:



Chip-blower on



Chip-blower off

9. Switch-on/off of the instrument cooling
10. Changing the type of instrument cooling Possible Settings: air, water, spray
11. Setting the quantity of instrument cooling water
12. Buttons for quick pre-selection of the quantity of the instrument cooling water
13. The instrument torque value indicator

Program Panel. The dentist can save up to 10 different instrument Settings and then quickly

14. recall them during work by pressing the appropriate program on the tablet or using foot control. See chapter Instrument programs

5.5.3 Micro-motor DX PRO, DX PRO BLUE

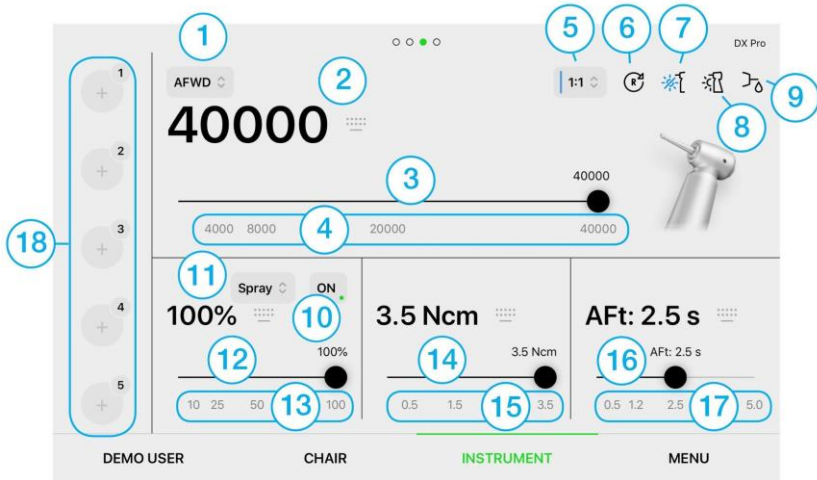

1. Selection of the micro-motor operating mode NORMAL, AUTO-REVERSE, AUTO-FORWARD
2. Direct Setting of the micro-motor revolutions using the keyboard.
3. Setting the maximum micro-motor revolutions.
4. Buttons for the micro-motor revolutions quick selection
5. Nozzle gear ratio
6. Changing the direction of the micro-motor rotation - R to the right - L to the left
7. Lighting of the instrument - blue light (only available in DX BLUE version).
Possible Settings:



Lighting on



Lighting off

8. Instrument lightning.
Possible Settings:



Lighting on



Lighting off

Automatic instrument chip-blower.

9. This function is active only when cooling is switched on. When switched on, the cooling air continues to run for 0.5 seconds after the instrument is stopped.
Possible Settings:



Chip-blower on



Chip-blower off

10. Switch-on/off of the instrument cooling
11. Changing the type of instrument cooling Possible Settings: air, water, spray
12. Setting the quantity of instrument cooling water
13. Buttons for quick pre-selection of the quantity of the instrument cooling water
14. Setting of the instrument torque value indicator
15. Buttons for quick pre-selection of the instrument torque value
16. Setting of the Auto-forward mode time

17 . Buttons for the quick selection of the Auto-forward mode time

- Program Panel. The dentist can save up to 10 different instrument Settings and then quickly recall them during work by pressing the appropriate program on the tablet or using foot control. See chapter Instrument programs

5.5.4 Micro-motor DX SRG

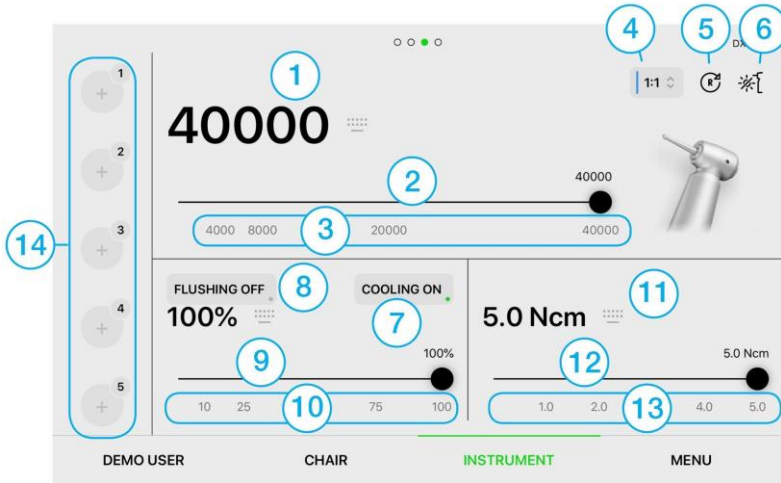

1. Direct Setting of the micro-motor revolutions using the keyboard
2. Setting the maximum micro-motor revolutions.
3. Buttons for the micro-motor revolutions quick selection
4. Nozzle gear ratio
5. Changing the direction of the micro-motor rotation - R to the right - L to the left
6. Instrument lightning.
Possible Settings:



Lighting on



Lighting off

7. Switch-on/off of the instrument cooling - peristaltic pump
8. Switch-on / off of the flushing - the flushing is started with the foot control.
The micro-motor is stopped.
9. Setting the quantity of cooling water for instrument and flushing
10. Buttons for quick selection of the quantity of the cooling water for instrument and flushing
11. Direct Setting of the instrument torque value indicator
12. Setting of the instrument torque value indicator
13. Buttons for quick pre-selection of the instrument torque value
14. Program Panel. The dentist can save up to 10 different instrument Settings and then quickly recall them during work by pressing the appropriate program on the tablet or using foot control.
See chapter Instrument programs

5.5.5 Ultra-sound scaler – SATELEC NEWTRON LED, SATELEC XINETIC

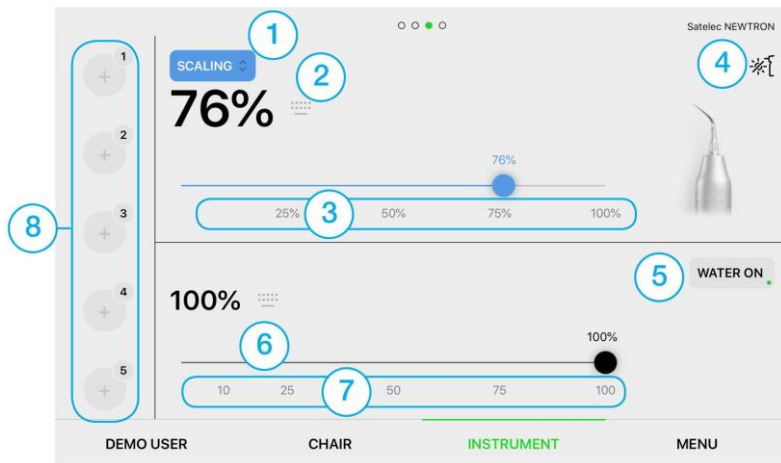



1. Selection of the scaler mode according to the type of terminal used

2. Setting the maximum power of the scaler.
By the Setting it is possible to limit the maximum power of the instrument to the desired value.

3. Quick selection of the scaler pre-selected maximum power

4. Instrument lighting (if the scaler is equipped with lighting)
Possible Settings:

	Lighting on		Lighting off
---	-------------	---	--------------

5. Switch-on / off the cooling water

6. Setting the quantity of instrument cooling water

7. Quick pre-selection Setting of the instrument cooling water quantity

8. Program Panel. The dentist can save up to 10 different instrument Settings and then quickly recall them during work by pressing the appropriate program on the tablet or using foot control.
See chapter Instrument programs

5.5.6 Ultra-sound scaler – LM PRO POWER

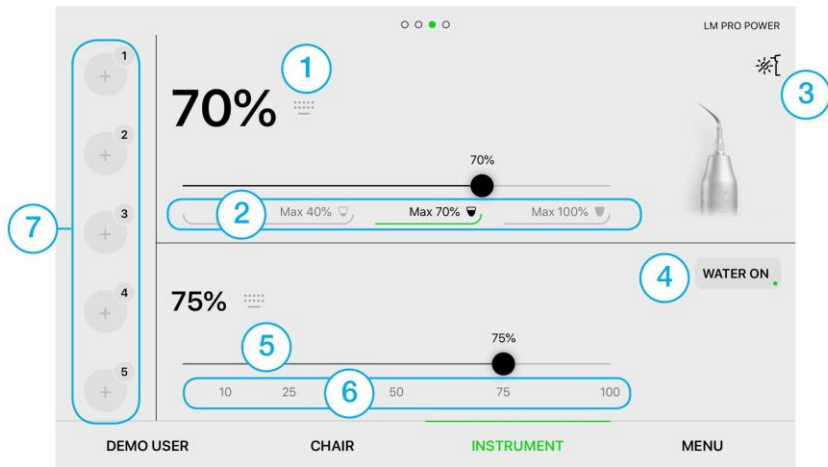

1. Setting the maximum power of the scaler. By the Setting it is possible to limit the maximum power of the instrument to the desired value.
2. Quick selection of the scaler pre-selected maximum power
3. Instrument lighting (if the scaler is equipped with lighting)



Lighting on



Lighting off

4. Switch-on/off of the instrument cooling
 5. Setting the quantity of instrument cooling water
 6. Quick pre-selection of Setting the quantity of the instrument cooling water
- Program Panel. The dentist can save up to 10 different instrument Settings and then quickly recall them during work by pressing the appropriate program on the tablet or using foot control. See chapter Instrument programs

5.5.7 Ultra-sound scaler – EMS, DMETEC, WOODPECKER

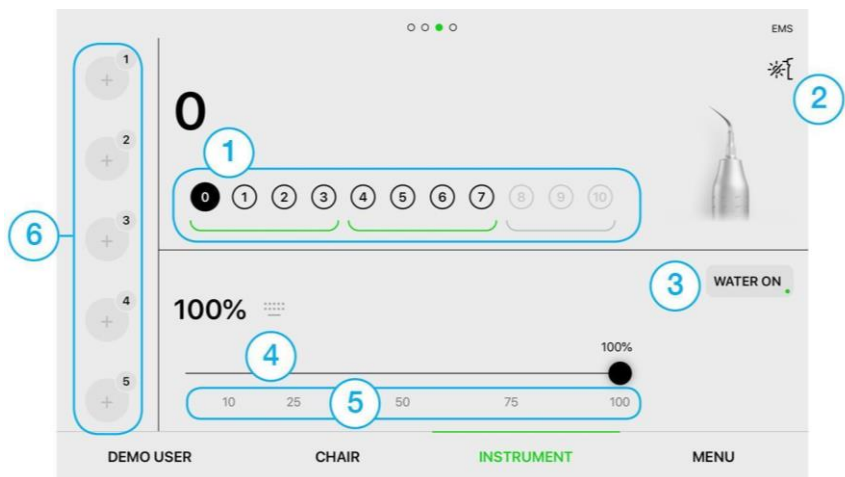

1. Quick selection of the scaler pre-selected maximum power

2. Instrument lighting (if the scaler is equipped with lighting)

Possible Settings:



Lighting on



Lighting off

3. Switch-on/off of the instrument cooling

4. Setting the quantity of instrument cooling water

5. Quick pre-selection of Setting the quantity of the instrument cooling water

6. Program Panel. The dentist can save up to 10 different instrument Settings and then quickly recall them during work by pressing the appropriate program on the tablet or using foot control. See chapter Instrument programs

5.5.8 Ultra-sound scaler – NSK

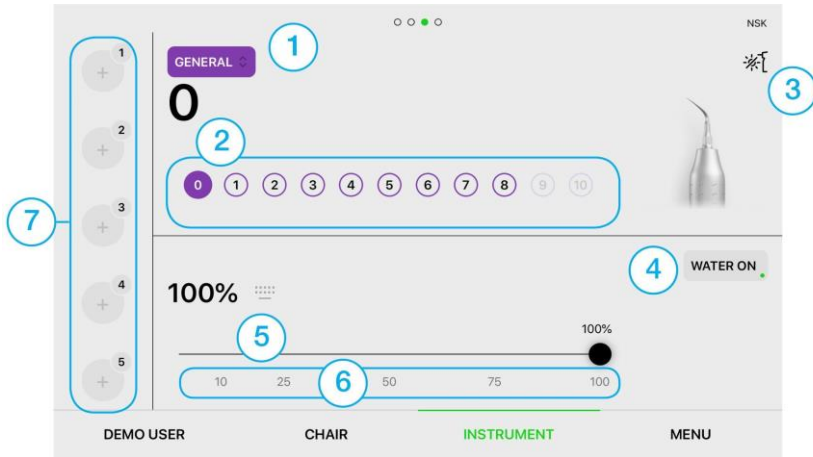

1. Selection of the scaler mode according to the type of terminal used
2. Quick selection of the scaler pre-selected maximum power
3. Instrument lighting (if the scaler is equipped with lighting)

Possible Settings:



Lighting on



Lighting off

4. Switch-on/off of the instrument cooling
 5. Setting the quantity of instrument cooling water
 6. Quick pre-selection of Setting the quantity of the instrument cooling water
- Program Panel. The dentist can save up to 10 different instrument Settings and then quickly recall them during work by pressing the appropriate program on the tablet or using foot control. See chapter Instrument programs

5.6 Instrument programs

- i. the instrument programming process applies to all instruments controlled on the doctor's element
- i. each instrument can have 10 different program Settings

The stored program is identified by a button change and the text below the instrument program button
The + key means that the instrument program is not created

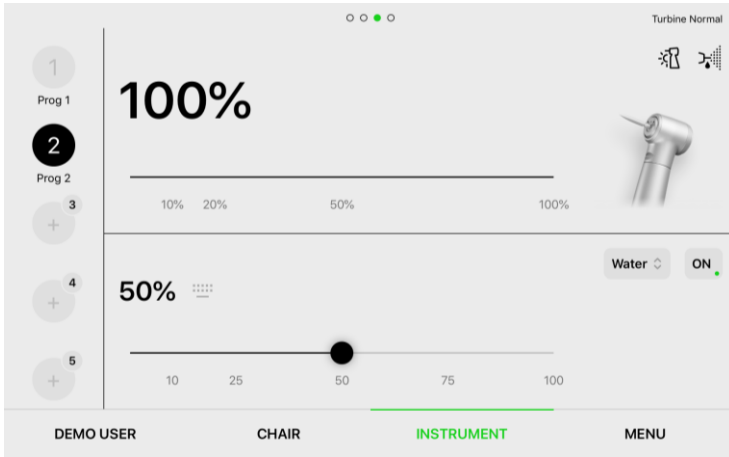

the button in the state without saving the instrument program



Prog 1

the button in the state of recalling the instrument program - it works with programmed instrument parameters



Prog 1

the button in the state with saving the instrument program

Creating the program

By long pressing and holding the button, current instrument parameters and Settings are saved.

- i. The program can be saved under any name
- i. The program name is displayed below the button

Recalling the program

By pressing the button, all parameters and Settings of the instrument are unit.

Saving the changes in an existing document

By long pressing the existing program button, the current instrument parameters and Settings are saved.

Deleting the program

By long pressing the existing program button, this program can be deleted.

- i. the currently used program cannot be deleted

5.7 Setting the foot control

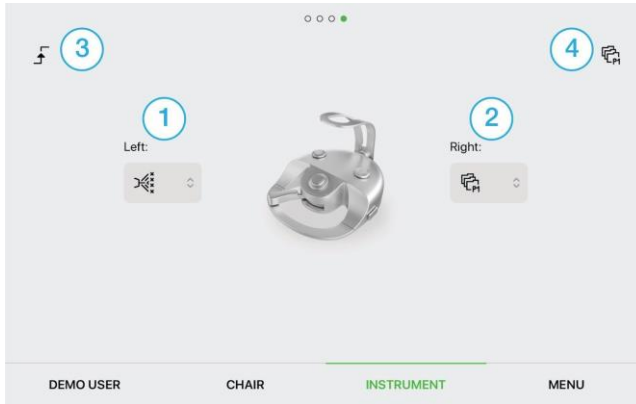

The screen is displayed by dragging finger on the screen to the left

1. Assigning a function for the left button
2. Assigning a function for the right button
3. Switching / regulation mode of the lever
Possible Settings:



Switching mode



Regulation mode

4. Selection from the programs for switching with the foot control button

Possible Settings for assigning left and right button functions:

i. program assignment is only available if the instrument program change function is unit on the side programmable buttons

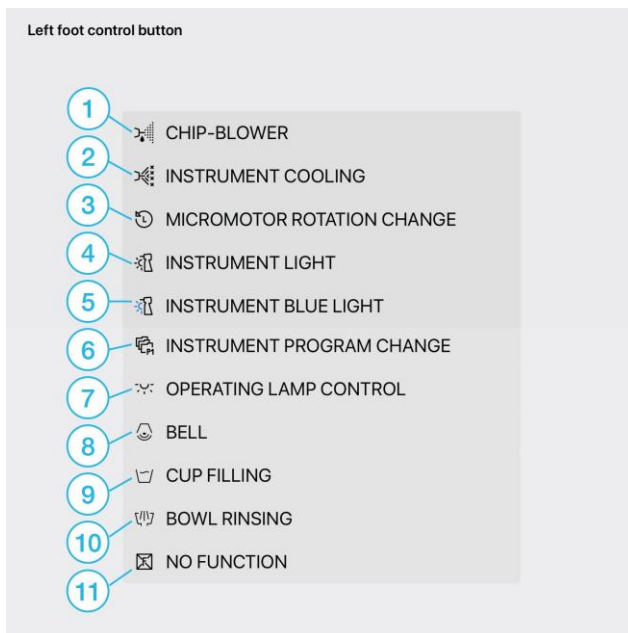

1. Chip-blower
2. Instrument cooling
3. Micromotor rotation change
4. Instrument light
5. Instrument blue light
6. Instrument program change
7. Operating lamp control
8. Bell
9. Cup filling
10. Bowl flushing
11. No function

6 Dental unit operation

6.1 Manipulation with the doctor's element for easier manipulation with the doctor's element, the pantographic arm is equipped with:

- mechanical brake - on the arm there is a wheel for mechanical adjustment of the braking force of the pantograph of the doctor's element,
- pneumatic brake - there is a pneumatic brake button on the doctor's table. By pressing, the pantographic arm of the doctor's table is automatically released.

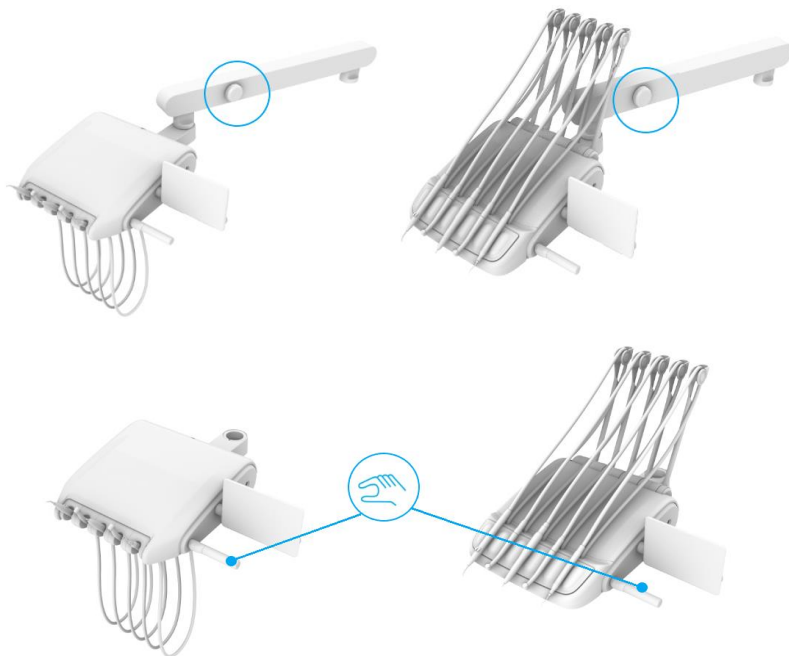

6.2 Whip lock

The doctor's element with the upper line of the instruments can be equipped with a so-called whip lock. The instrument whip is locked in a certain position by dragging the instrument towards you. To de-lock, drag the whip towards you to end position. The whip then returns to its basic position.

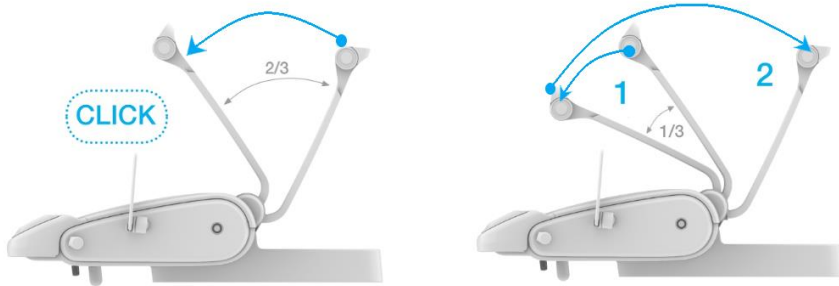

6.3 Foot control

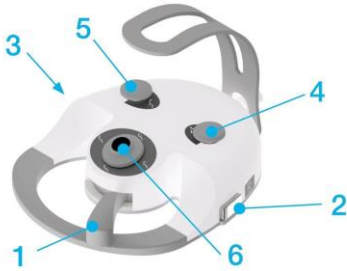

UNO foot control

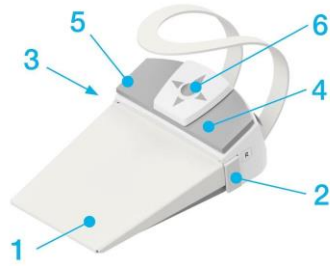

NOK foot control

Fool control buttons:

- | | |
|---|---|
| <ol style="list-style-type: none"> 1. Lever 2. Right side button - programmable function 3. Left side button - programmable function | <ol style="list-style-type: none"> 4. Recall of the chair program positions 5. The chair mounting position 6. Joystick for the chair control |
|---|---|
-

6.3.1 Controlling the instruments and the chair with the foot control

Foot control lever

1 is used for starting and regulating the rotary instrument revolutions and for starting and regulating the power of the scaler.

Controlling the chair

By moving the joystick **6** it is possible to control the basic movements of the chair up, down, back-rest up, back-rest down.

The chair mounting position

By pressing the button **5** the chair mounting position is recalled

Recalling the chair program positions

<p>Program position no. 1 (see the chapter 5.4.1) is recalled by pressing the button 4 and subsequent by moving the joystick upwards.</p>	<p>Program position no. 2 is recalled by pressing the button 4 and subsequent by moving the joystick downwards.</p>
---	---

<p>Program position no. 3 is recalled by pressing the button 4 and subsequent by moving the joystick to the left.</p>	<p>Program position no. 4 is recalled by pressing the button 4 and subsequent by moving the joystick to the right.</p>
---	--

*i. the second pressing / movement of the joystick must occur within two seconds after pressing the button no. **4**, otherwise the position will not be recalled.*

6.3.2 Charging the battery of the wireless foot control

There are two ways to charge the wireless foot control battery.

- **Charging using a connecting cable with a dental unit.**

Connect the connecting cable to the foot control connector and then connect the other connector to the connector in the dental unit.

- **Charging from the mains using a charger.**

Connect the charger cable to the foot control connector, then connect the charger to a wall outlet.

6.4 Cuspidor

6.4.1 Filling-up the distilled water

Distilled water is used to cool the instruments on the doctor's control panel, as well as to power the syringes on the doctor's control panel and the assistant's panel.

Distilled water is poured into the bottle through a funnel located under the front cover of the spittoon block. The container, a bottle of distilled water is placed in a spittoon block. For service purposes (seal replacement, bottle replacement), the bottle is accessible and removable after opening the spittoon block door.

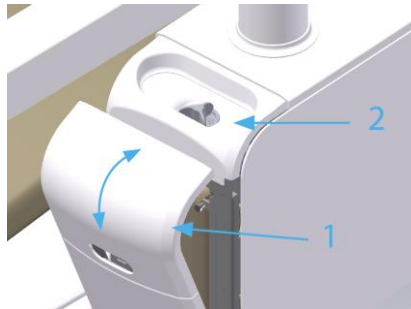

Filling-up the distilled water:

- open the front cover of the spittoon block **1** (the waterway system is automatically depressurised)
- unscrew the stopper in the funnel **2**
- top up with distilled water. During the filling, an intermittent sound signal sounds, the interval of which is shortened by topping up. A continuous beep indicates that the bottle is full.
- unscrew the plug in the funnel **2**
- close the front cover of the spittoon block **1** (the waterway system is automatically pressurized)

Use only distilled water intended for medical purposes with maximum conductivity up to 2000 $\mu\text{S}/\text{cm}$.

Do not use demineralised water for technical purposes!

The manufacturer recommends replacing the distilled water bottle at least once a year.

i. If the dental unit is not equipped with a hygiene system, it is necessary to pour distilled water with a mixed disinfectant solution into the bottle. For more information, see chapter 7.1 Disinfection of water paths of instrument cooling - Manual hygien

6.4.2 Filling-up and change of solutions for the automatic hygiene system

If the dental unit is equipped with a Diplomat automatic hygiene system, in the cuspidor, in addition to the bottle for distilled water, there are bottles for solutions for decontamination waterways and decontaminating suction.

The automatic hygiene system automatically detects a lack of liquid in the bottles and does not start the hygiene procedure. The application prompts you to add the appropriate fluid. The waterway disinfection solution bottle **1** is accessible from the right side in the spittoon block,

The suction decontamination solution bottle **2** is accessible from the left side of the spittoon block.



Hygiene bottles can be unscrewed at any time during work and filled-up with the appropriate solutions.



Do not unscrew the bottles of solutions or do not fill-up hygiene solutions during the ongoing hygiene process! The bottles are under pressure.

If the dental unit is equipped with a WEK water treatment unit, the system will automatically alert you to the missing Green & Clean WK solution located in the spittoon block. The shrink solution bottle **2** is replaced. It is not filled-up.

Carefully pull the plug **1** with the tube out of the neck of the empty bottle and insert it into the new bottle **2**.

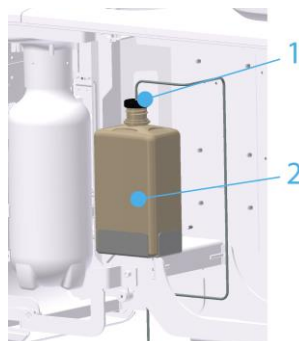

6.4.3 Central water supply

Water from the central drinking water supply can be used to cool the instruments and power the syringes. If the unit is equipped with this function, you can activate it by toggling the cooling type selection switch

located in the spittoon block to position



6.5 Assistant's table

6.5.1 Assistant's table with keyboard



Assistant's table



Assistant's table keyboard

6.5.1.1 Assistant's table keyboard

Button	Description	Button	Description
	Filling the cup		Flushing the bowl
	Rotating the bowl		Hygiene (for PRO MODEL not available)
	Main lamp		Bell
	The chair flushing position		The chair mounting position
	The chair previous position		Trendelenburg chair position
	Moving the chair upwards		Moving the back-rest upwards
	Moving the chair downwards		Moving the back-rest downwards
The chair program positions P1 to P4			

6.5.2 Assistant's table without a keyboard



Assistant's table

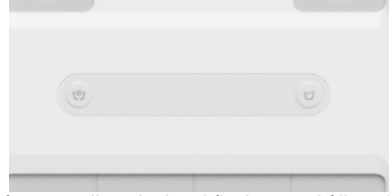

Buttons for controlling the bowl flushing and filling the cup

6.5 Assistant's table equipment

Saliva ejector

It is activated automatically when removed from the holder. The operation ends when it is inserted into the holder.



The saliva ejector (terminal) is disposable, it is not intended for repeated use. If the saliva ejector (terminal) is used in another patient, there is a risk of damage to his/her health

Small suction hose, big suction hose

It is activated automatically when removed from the holder. The operation ends when it is inserted into the holder. The exhauster suction can be regulated by opening the suction control flap.

i. In the service menu, it is possible to unit a five-second delay for switching off the suction. Currently only available for service technicians.

Polymerizing lamp

The polymerization lamp is ready for operation after the removal. To use the polymerizing lamp, please read the instructions for the polymerizing lamp model.

Intra-oral camera

It is used for better visualization during dental procedures.

The camera includes:

- holder
- USB flash drive
- the instrument itself (camera)

To use the intra-oral camera, please read the instructions for your intra-oral lamp model



Protect the product from water, do not store in humid areas

6.6 Lamp

6.6.1 Xenos lamp

The Xenos dental lamp is designed for use in dental practice to illuminate the oral cavity. The light source is two highly luminous LEDs. They radiate homogeneous white light (3700K - 4000K). The light trace is formed using two parabolic reflecting glasses with back reflection. The light trace achieved in this way allows the dentist to work with excellent colour resolution and without disturbing influences.

6.6.1.1 Technical data

Parameters	Value
Max. input	10 VA
Type of protection against electric shock	II.
The optimal light trace is the distance of	700 mm
Nominal size of the light trace	max. 70 x 160 mm
Correlated colour temperature	3700 K – 4000 K
Lighting intensity	5500 lx – 26000 lx
Weight	1 kg ± 0.1 kg

6.6.2 Faro Maia LED lamp

The Faro dental lamp is designed for use in dental practice to illuminate the oral cavity. The light source is two highly luminous LEDs. They radiate homogeneous white light (5000 K). The light trace is formed using two parabolic reflecting glasses with back reflection.

6.6.2.1 Technical data

Parameters	Value
Max. input	9 VA
Type of protection against electric shock	II.
The optimal light trace is the distance of	700 mm
Nominal size of the light trace	max. 100 x 175 mm
Correlated colour temperature	5000 K
Lighting intensity	3000 lx – 35000 lx
Weight	1 kg ± 0.1 kg

6.6.3 Lamp control



Position of non-contact sensors for lamp control

Both lamps are controlled in the same way.



It is possible to work with lamps in two modes - light intensity levels. In the higher, operating light intensity mode, it is possible to unit the light intensity range from 8000 lx to 26000 lx in the case of the Xenos lamp. In the case of the Faro Maia LED lamp, the range is from 8000 lx to 35,000 lx.

In the mode designed for working with composite materials, it is possible to unit a lower light intensity in the case of the XENOS lamp from 5500 lx to 8000 lx and in the case of the Faro Maia LED lamp from 3000 lx to 8000 lx.

The light intensities of both modes can only be unit via the Connect application in the tablet.

i. To unit the light intensity of the lamp, see chapter 5.2 Quick Settings and chapter 5.3.3 Setting the lamp

Control of the lamp at the level of switching on and switching between lighting modes is possible from four places on the dental unit:

- From the Diplomat Connect application.
(see the chapter 5.1.1 Control of basic functions)
- By a sensor located on the lamp.
 1. By holding your hand in front of the sensor, the lamp lights up for the operating light.
 2. By repeated brief holding the hand in front of the sensor, while the lamp is lit will change its intensity.
 3. By long holding the hand in front of the sensor, while the lamp is lit will switch-off the lamp.
- By a button on the nurse's table keyboard.
 1. By pressing the button  the lamp illuminates with the intensity for the operating light.
 2. By repeated pressing the button  while the lamp is on changes its intensity.
 3. By pressing and holding the button  while the lamp is on, it switches-off the lamp.
- By the side programmable foot control button.
The control works in the same way as the control via a key on the assistant's keyboard. (see also the chapter 6.5 Foot control)

6.7 Chair

The dental unit can be equipped with two chair constructions.

The chair in the basic version, where the seat does not cradle function when the back-rest is moved.

The chair in the version, where the seat does cradle function when the back-rest is moved.

i. For the positions and ranges of seat cradle functioning, see the chapter 1.2 Technical data

i. Both chair constructions reach the Trendelenburg position

6.7.1 Chair control

All movements of the chair can be controlled via the Diplomat connect application from the tablet, from the keyboard of the assistant's table and via the foot control.

i. For the ways to control the chair via Diplomat Connect application, see the chapter 5.4 Chair control

- The way of controlling standard movements, recalling and programming the positions of the chair from the assistant's keyboard is identical to the control from the Diplomat connect application on the tablet. Each press of the key on the Assistant keyboard appears in the application on the tablet.

i. For the chair control methods via the foot control, see the chapter 6.5.1 Controlling the instruments and the chair via the foot control

6.7.2 Head-rest control

The mechanism for the head-rest position Setting can be in four versions.

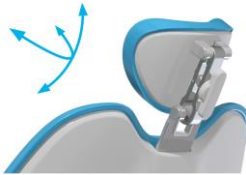
	Head-rest	Direction of movement:	Securing the position
1.	<p>2D MECHANICAL</p> 	Forwards / Backwards	Mechanically by turning the lever
2.	<p>3D MECHANICAL</p> 	Forwards / Backwards To the sides	Mechanically by turning the lever

3.	3D PNEUMATICAL		Forwards / Backwards To the sides	Pneumatically by pushing a button
----	-------------------	--	---	--------------------------------------

- The mechanical head-rest incline is unit by releasing the lever located on the back of the head-rest. After reaching the desired position, the back-rest must be locked again with the lever.
- The pneumatic back-rest incline is unit by pressing the pneumatic brake button. When the desired position is reached, release the pneumatic brake button.
- Height Setting is performed mechanically, by pulling or pressure in the direction of the Setting.

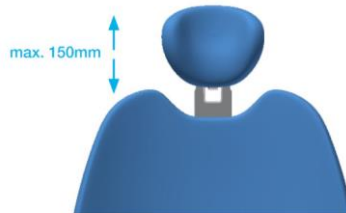

When working with a patient, we recommend using an external protective cover for the head-rest.
The protective sleeve protects the upholstery from damage by hair products.
Complaints may not be accepted in case of damage to the head-rest by hair products.

6.8 Hand-rest

The folding hand-rest can be folded back (movement no. 1) or folded forward (movement no. 2).

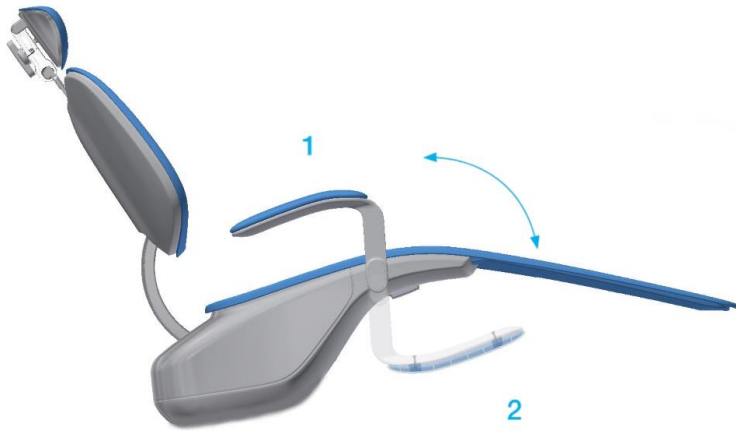

6.9 Converting the dental unit

i. Available only for the version of the dental unit with the possibility to convert for using by left-handed doctors.

The converting proceeds via the following steps:

1. Go with the unit in the lowest position.
2. Slightly lower the backrest - to about a one third position.

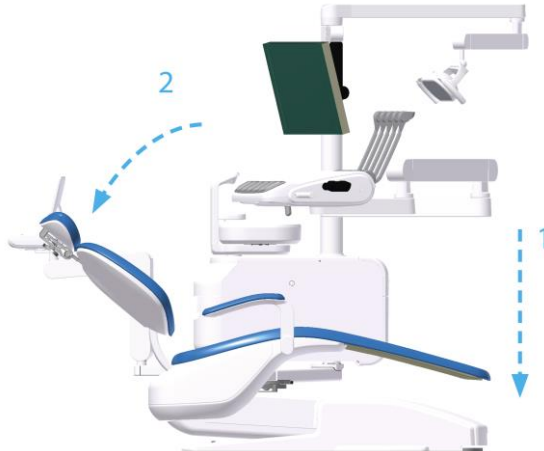

3. Release the seat from the chair construction with a screw.

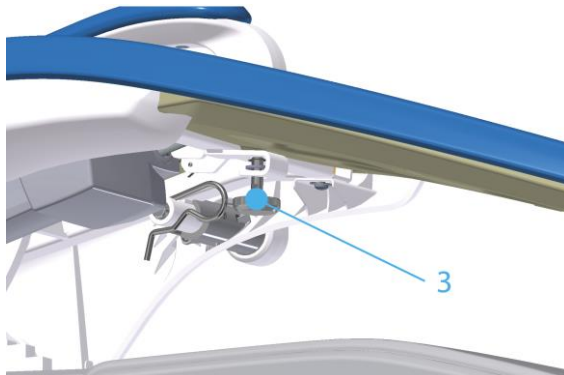

4. Raise the seat.

5. Arrest it with a support.
6. Release the spittoon block arm brake.

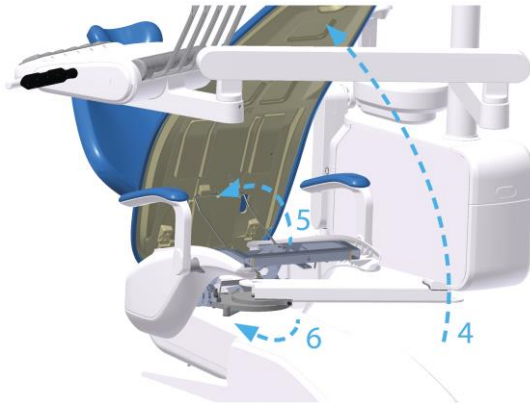

7. In the spittoon block, release the stop of the doctor's table arm by moving it upwards and sideways.

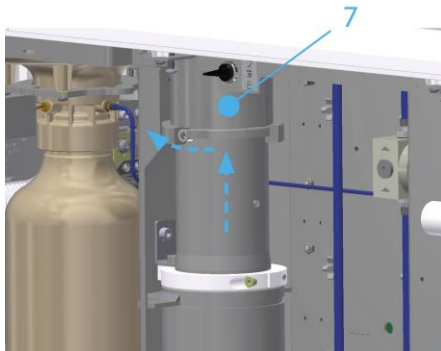

8. Move the dental unit to the other side.
 - a. Rotate the dental unit so that all elements of the unit - the spittoon block, the arms of the doctor's table, the lamp and the assistant arm - are always in the direction of rotation.



8. a.1



8. a. 2



8. a. 3



8. a. 4

9. When rotation is complete, apply the spittoon arm brake.
10. Lower the seat support.
11. Lower the seat.

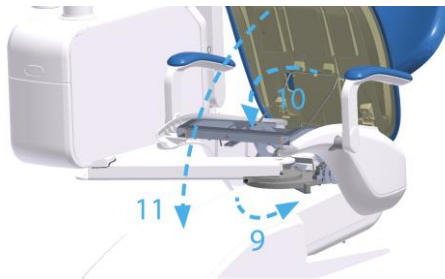

12. Tighten the seat with the screw.

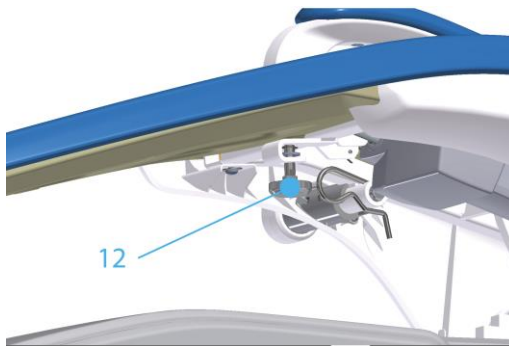

13. Turn the spittoon block with the assistant arm into the working position.



14. Move the doctor, lamp, and monitor arms to the working position.



When moving the unit to the other side, care must be taken to ensure that the arms of the doctor's table and the lamp are always as much as possible above the floor plan of the dental unit and do not hit objects in the outpatient clinic.



The convertible unit can be installed on a chair with a structure that must be firmly anchored to the concrete floor. **Under no circumstances should the unit be converted to an unanchored chair. There is a risk of the unit tipping over.**

6.10 Completion of the work with the dental unit

After completion of the work, take the following steps:

- switch-off the unit with the main power switch
- switch-off the tablet
- close the main water supply
- switch-off the compressor and the suction unit

6.11 Safety sensors

The dental unit is equipped with safety sensors that are activated in the event of a collision. The movement of the chair is blocked if one of the safety switches is activated or any instrument (except the syringe) is triggered from the doctor's control panel.

6.11.1 Carried dental units

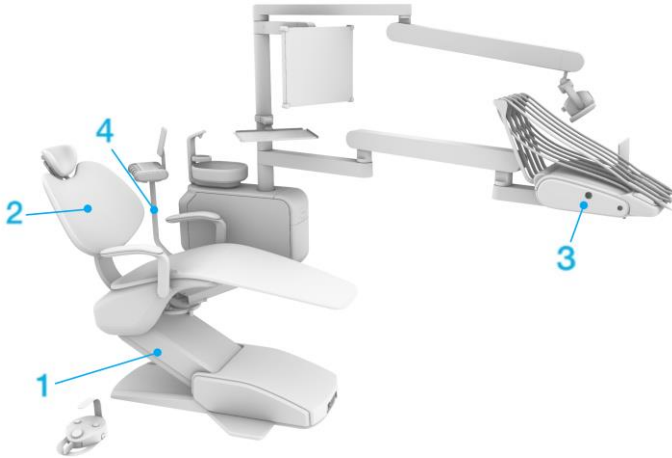

	Part of the unit	Sensor activation	Unblocking the sensor
1.	Chair	In the event of the chair collision while moving down	By removing the blocking object
2.	Back-rest	In the event of a back-rest collision while moving downwards	By removing the blocking object
3.	Control panel	Blocking of the chair movement is activated by lowering the instrument with the foot control	By completing the work with the instrument
4.	Assistant's arm	In the event of a collision of the assistant's arm while moving downwards	By removing the blocking object

6.11.2 Stationary dental units

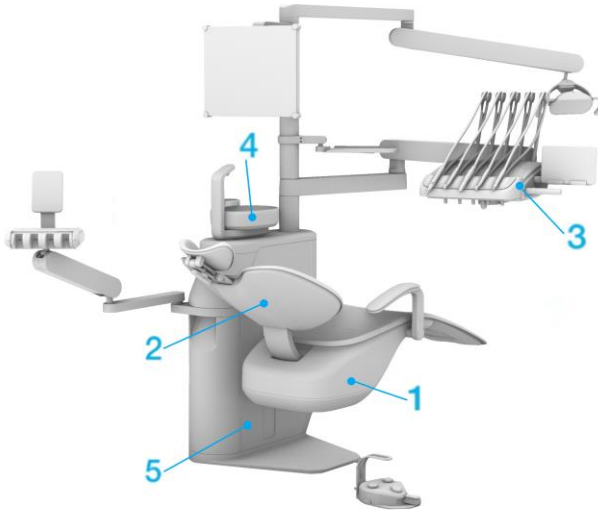

	Part of the unit	Sensor activation	Unblocking the sensor
1.	Chair	In the event of the chair collision while moving down	By removing the blocking object
2.	Back-rest	In the event of a back-rest collision while moving downwards	By removing the blocking object
3.	Control panel	Blocking of the chair movement is activated by lowering the instrument with the foot control	By completing the work with the instrument
4.	Bowl	The turned bowl blocks the movement of the chair only if the cooling water chair is above the collision sensor	By turning the bowl to the basic position
5.	Motor	The chair stops moving when the motor overheat thermal sensor is activated	By cooling the motor

7 Product maintenance - cleaning, disinfection and decontamination

7.1 Disinfection of the instrument cooling waterways - Manual hygiene

If the unit is not equipped with an automatic system of hygiene of waterways and suction hoses, it is necessary to perform regular hygiene manually.

7.1.1 Daily disinfection

During the work, we recommend using Alpron, Sanosil S003 or Dentosept P in a 1% concentration with distilled water. The solutions are poured through a funnel into a bottle of distilled water. Agents at 1% concentration are harmless to the patient's health. With regular use, the water cooling system is kept clean and no other disinfectants need to be used.

If water from the central distribution is used to cool the instruments, daily hygiene is performed as follows:

1. Fill a distilled water bottle with a 1% solution of disinfectant and distilled water.
2. Use the switch in the spittoon block to activate the "bottle" water source.
3. By gradual pulling out the instruments and subsequent starting (by the foot control), flushing the waterways of all instruments gradually for at least 10 s. Flushing the first instrument in sequence (syringe is recommended) for 30 seconds until the disinfectant solution gets from the bottle to the doctor's table.
4. Activate back the water source from the central distribution by the switch in the spittoon block.

We recommend performing the above disinfection of the waterways of the instruments at least once a day. Most preferably at the end of the working day, while in the morning of the next working day we recommend flushing all waterways with water from the central distribution. Flushing each instrument for at least 20 seconds.

7.1.2 Intensive disinfection of the instrument waterways

Intensive disinfection consists in the targeted addition of a higher concentration of disinfectant solution. Intensive disinfection is not used during procedures on patients.

All waterways and dosing devices must be flooded with disinfectant solution. The disinfectant solution must remain in the waterways of the unit for the period specified by the manufacturer. After the specified exposure time, the solution must be flushing operating light sufficiently.

It is recommended to perform the intensive disinfection:

1. cyclically, at least quarterly,
2. at high load by microorganisms,
3. after a long break, the recommendation is always if the dental unit has not been worked on for more than three days.

The process of intensive disinfection is as follows:

1. fill a distilled water bottle with 100% Alpron disinfectant concentrate. In case of using another disinfectant, use the concentration prescribed by its manufacturer.
2. Use the switch in the spittoon block to activate the "bottle" water source.

3. By pulling out the instrument and subsequent starting, gradually fill the waterways of all instruments with the concentrate until the disinfectant solution starts to flow out of the instrument.
4. The unit can be switched off.
5. Leave the Alpron disinfectant solution to act for a minimum of 60 minutes, but a maximum of 50 hours. In case of using another disinfectant, observe the exposure time specified by its manufacturer.
6. Fill the distilled water bottle with distilled water.
7. Gradually flushing each instrument individually for a at least 120 seconds.

7.2 Disinfection of instrument cooling waterways - Automatic hygiene

The automatic hygiene of the instrument waterways is controlled by the electronics program. It is available for dental units that are equipped with it.

It provides four options:

1. Hygiene at the beginning of the working day
2. Hygiene after a surgery
3. Hygiene at the end of the working day
4. Intensive hygiene

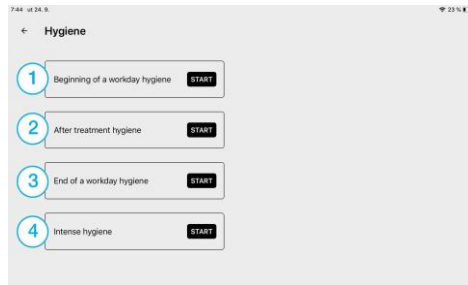

7.2.1 Hygiene at the beginning of the working day

i. this hygiene must always be started if "Hygiene at the end of the working day" has not been performed on the previous working day.

1. **PREPARATION** - Put the instrument hygiene holder into the bowl and press the **CONTINUE** button
2. **PREPARATION** - Put the instrument hoses into the hygiene holder and press the **CONTINUE** button

If the assistant's table is equipped with a syringe, this syringe must also be inserted into the holder.

Before putting the syringes into the hygiene holder, it is necessary to slide the hoop onto the syringes, which will ensure that the waterway button is pressed.



If the dental unit is equipped with a decontamination system, it is necessary to slide the suction hoses onto the hygiene mouthpieces as shown in the illustration.



3. **FLUSHING TIME** - select the instrument hoses flushing time by moving the slider. The recommended flushing time with the central distribution water is 120 s. If a 1% bottle solution is used for cooling, it is possible to shorten the flushing time to at least 20 s.
4. Press the **START** button to start the flushing process.

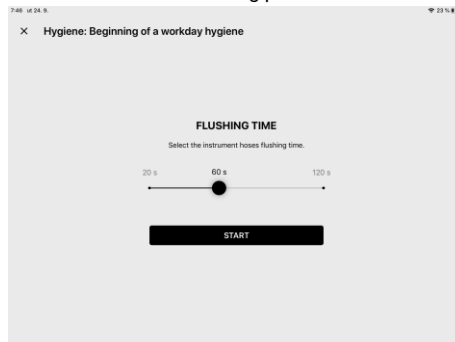

5. **FLUSHING IN PROGRESS** - the progress of flushing individual instruments is displayed on the screen. Press the STOP button to stop flushing.
6. **FLUSHING SUCCESSFULLY COMPLETED** - Flushing completed, put the instrument hoses into holders.

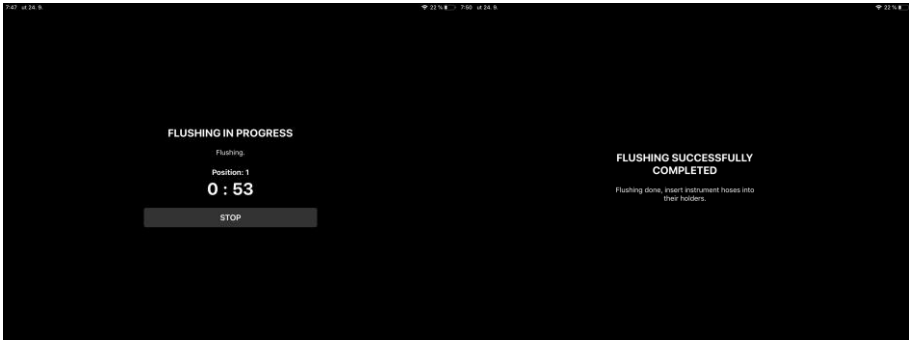

i. If necessary, the flushing can be interrupted at any time and terminated prematurely by pressing the STOP button

7.2.2 Hygiene after the procedure

i. This hygiene does not need to be used if a 1% bottle solution is used to cool the instruments. The hygiene process consists of identical steps as Hygiene at the beginning of the working day. The recommended flushing time is 20 s.

i. If necessary, the hygiene process can be interrupted at any time and terminated prematurely by pressing the STOP button

7.2.3 Hygiene at the end of the working day

The system ensures the filling of all waterways, including the filling of the cup, with 1% concentrate of disinfectant solution.

i. This hygiene must be started every day before the end of working hours.

i. This hygiene does not need to be used if a 1% bottle solution is used to cool the instruments.

1. PREPARATION - Put the instrument hygiene holder into the bowl and press the CONTINUE button
2. PREPARATION - Put the instrument hoses into the hygiene holder and press the START button

If the assistant's table is equipped with a syringe, this syringe must also be inserted into the holder. If the dental unit is equipped with a decontamination system, it is necessary to slide the suction hoses onto the hygiene mouthpieces as shown in the illustration.

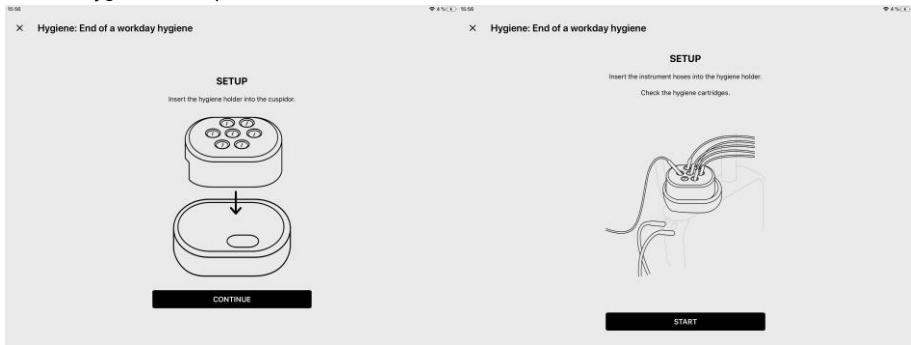

3. FILLING BY SOLUTION - the progress of filling with a solution of individual instruments is displayed on the screen. Press the STOP button to stop filling with solution.

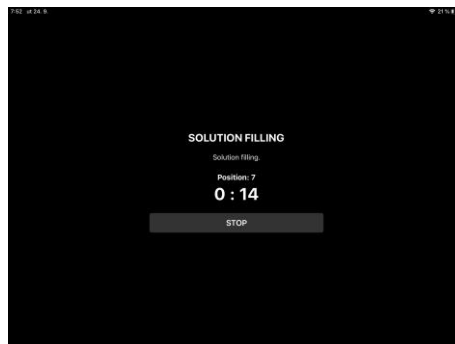

4. SOLUTION EXPOSURE - The solution exposure time is displayed on the screen. The dental unit can be switched off.
5. TO START FLUSHING - by starting the flushing, the screen for Setting the flushing time is displayed.

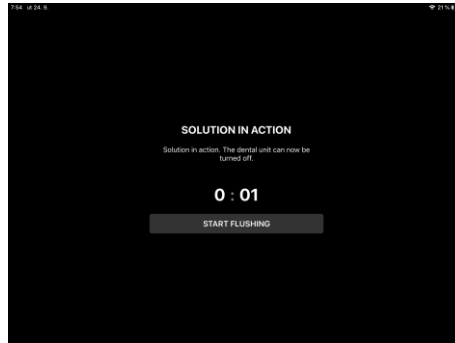

6. FLUSHING TIME - select the instrument hoses flushing time by moving the slider. The recommended flushing time with the central distribution water is 120 s.

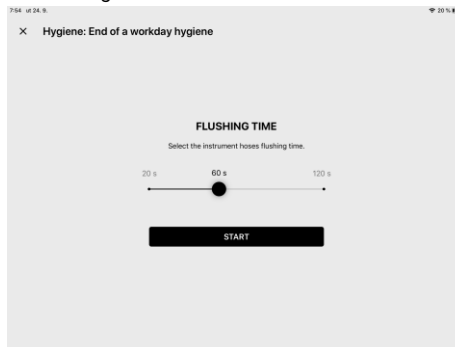

The following steps are identical to steps 4, 5, 6 of the chapter 7.2.1

7.2.4 Intensive hygiene

The system ensures the filling of all waterways, including the filling of the cup, with 100% concentrate of disinfectant solution.

This hygiene must be started:

1. cyclically, at least quarterly,
2. at high load by micro-organisms,
3. after a long break, the recommendation is always if the dental unit has not been worked on for more than three days.

1. PREPARATION - Put the instrument hygiene holder into the bowl

2. **PREPARATION** - Put the instrument hoses into the hygiene holder
If the assistant's table is equipped with a syringe, this syringe must also be inserted into the holder.
If the dental unit is equipped with a decontamination system, it is necessary to slide the suction hoses onto the hygiene mouthpieces as shown in the illustration.

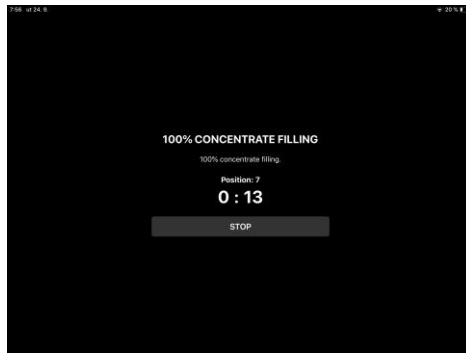
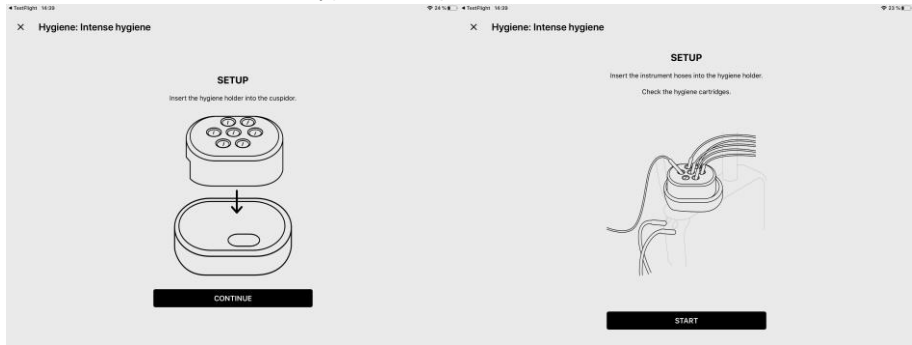

3. **FILLING WITH 100% CONCENTRATE** - the progress of filling individual instruments is displayed on the screen. Press the STOP button to stop filling.

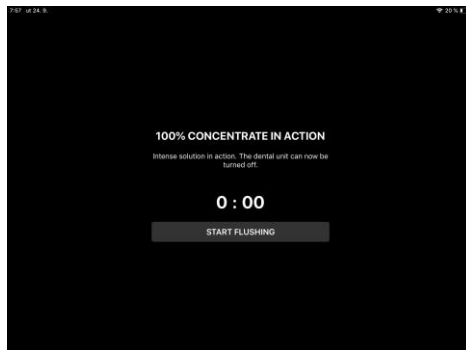

4. 100% CONCENTRATE EXPOSURE - The exposure time is displayed on the screen. The dental unit can be switched off.
5. TO START FLUSHING - by starting the flushing, the screen is displayed without Setting options of flushing time.

i.- For this type of hygiene, the fixed flushing time is 120 s.

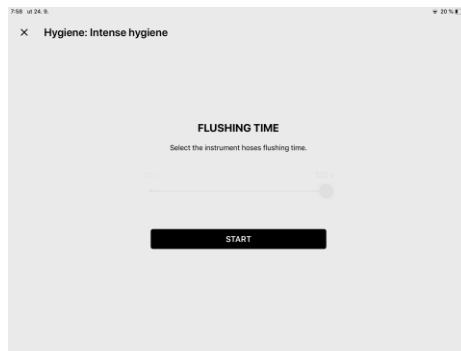

The following steps are identical to the steps 4, 5, 6 of the chapter 7.2.1
i. Flushing cannot be stopped prematurely. In case of flushing interruption the system will ensure its correct termination.

7.3 Disinfection of instrument cooling waterways - Semi-automatic hygiene

Semi-automatic hygiene requires manual replacement and mixing of disinfectant solution concentrations.

It provides two options:

1. Flushing
2. Semi-automatic hygiene

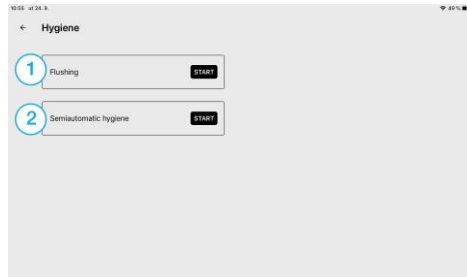

7.3.1 Flushing

The system automatically ensures the gradual flushing of the instrument waterway hoses.

1. PREPARATION - Put the instrument hygiene holder into the bowl
2. PREPARATION - Put the instrument hoses into the hygiene holder and check the level of distilled water

If the assistant's table is equipped with a syringe, this syringe must also be inserted into the holder.

If the dental unit is equipped with suction hygiene, it is necessary to slide the suction hoses onto the hygiene mouthpieces as shown in the illustration.

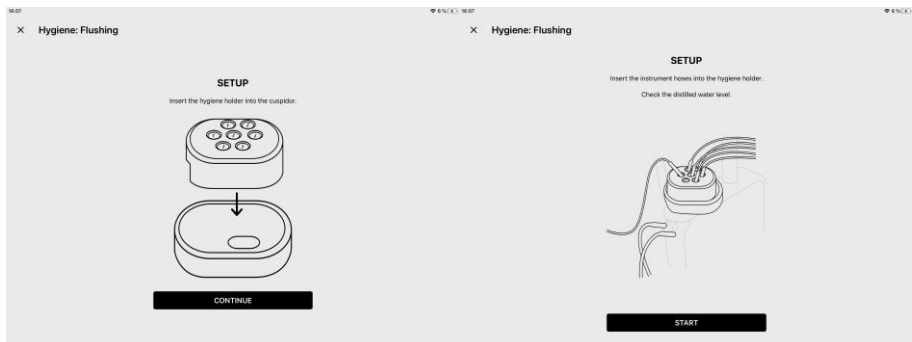

3. FLUSHING TIME - select the instrument hoses flushing time
4. The recommended flushing time with water is 120 s.
5. If a 1% bottle solution is used for cooling, it is possible to shorten the flushing time to at least 20 s.

6. The **START** button starts the flushing process.

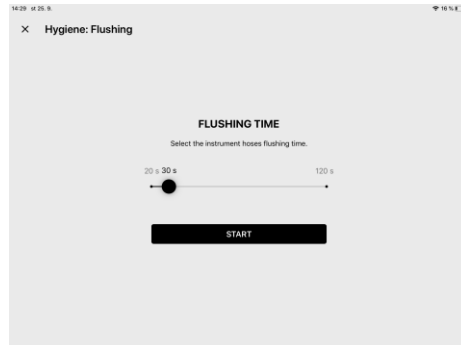

7. **FLUSHING IN PROGRESS** - the course of flushing of individual instruments is displayed on the screen.
8. **FLUSHING SUCCESSFULLY COMPLETED** - insert the instrument hoses into the holders.

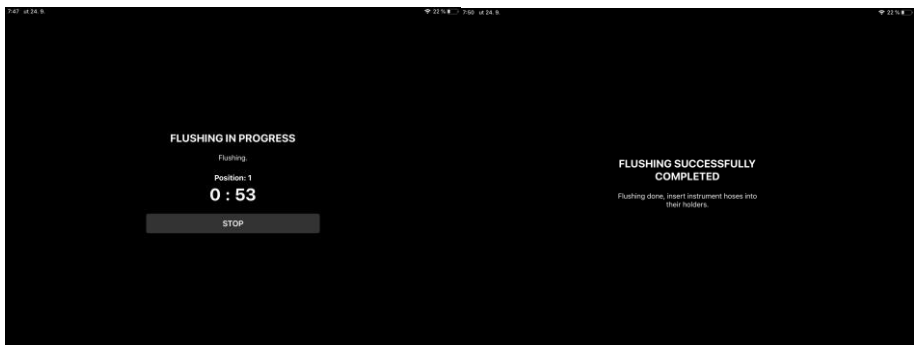

i. - if necessary, the flushing can be interrupted at any time and terminated prematurely.

7.3.2 Semi-automatic hygiene

The system ensures that all waterways are filled with a disinfectant solution, the ratio of which is mixed in a bottle intended for hygiene.

i. - this hygiene must be started:

1. At the end of the working day - a 1% solution is used
2. cyclically, at least quarterly - 100% concentrate is used
3. at high load by microorganisms - 100% concentrate is used
4. after a long break, the recommendation is always if the dental unit is not worked on for more than three days - 100% concentrate is used.

Procedure for semi-automatic hygiene:

1. PREPARATION - Put the instrument hygiene holder into the bowl
2. PREPARATION - Put the instrument hoses into the hygiene holder and replace the distilled water bottle with a bottle of disinfectant solution.

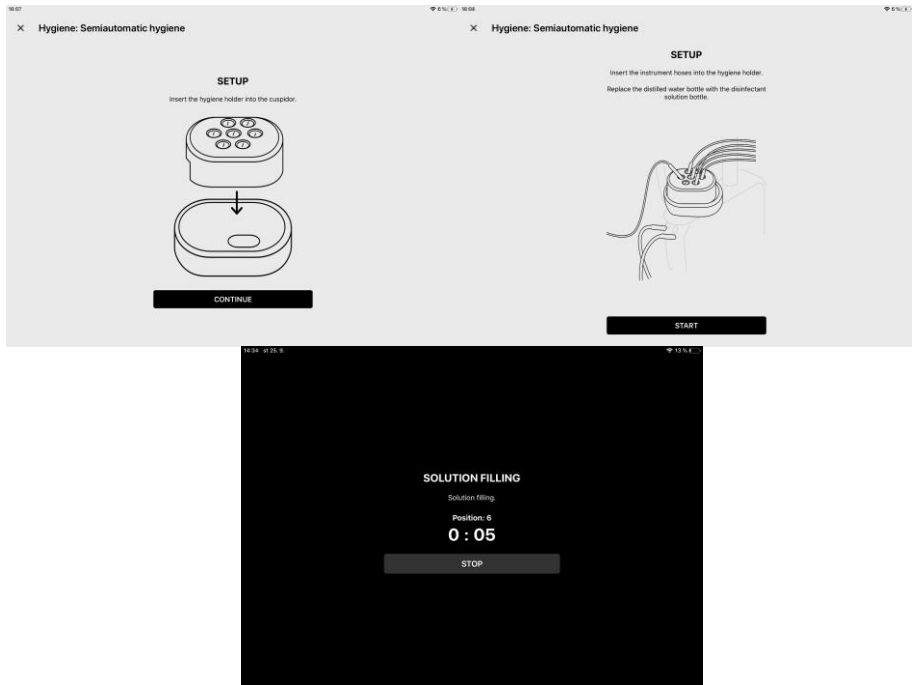

3. FILLING THE DISINFECTION SOLUTION - the progress of filling individual instruments is displayed on the screen. Press the STOP button to stop filling. By cancelling the filling process, it is possible to start flushing.

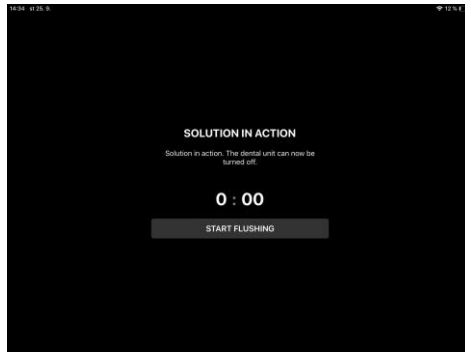

4. DISINFECTION SOLUTION EXPOSURE - The exposure time is displayed on the screen. The dental unit can be switched off.
6. TO START FLUSHING - by starting the flushing, the screen is displayed without Setting options of flushing time.

i.- For this type of hygiene, the fixed flushing time is 120 s.

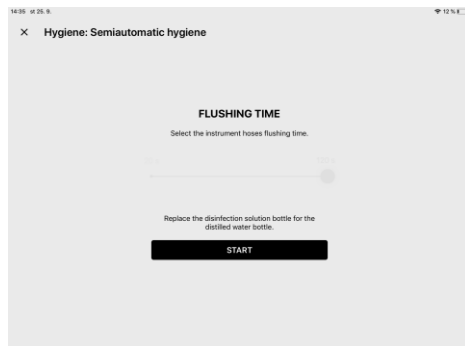

The following steps are identical to steps 4, 5, 6 of the chapter 7.2.1

i. - Flushing cannot be stopped prematurely. In case of interruption of the flushing, the system will ensure its correct termination.

7.4 Cleaning and decontamination of dental unit components

In addition to automated procedures for waterway hygiene and suction, it is also necessary to perform regular maintenance of the dental unit components, such as suction strainers, valve sieves and separators.

7.4.1 Cleaning and decontamination of the saliva ejector

There is a sieve in the end of the saliva ejector, which must be cleaned regularly and even if necessary. After each patient, it is necessary to flush the saliva ejector hose by sucking out 1 dcl of clean water. At the end of the working day, it is necessary to clean the saliva ejector hose by sucking out 1 dcl of a 1% cleaning solution intended for the hygiene of the suction systems.

1. Sieve



7.4.2 Cleaning and decontamination of big and small suction hoses

Select the suction terminals. Pull out the filters. Clean under running water and fold back. After each patient, flushing the suction hoses with approximately 1 dcl of water.

i. We recommend cleaning the filters at least once a day.

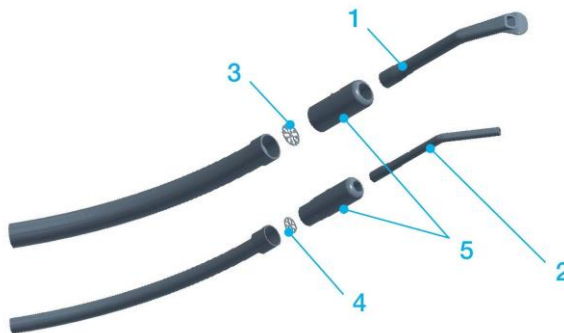

1. Big suction cannula
2. Small suction cannula
3. Gross filter P 22
4. Gross filter P 16
5. Suction control dampers

If the dental unit is not equipped with an automatic decontamination system, it is necessary to perform the hygiene manually. The choice of a suitable hygiene product depends on what other equipment is built into the suction system.

- In case if a CATTANI mini-separator is built into the unit, it is necessary to use PULI - JET PLUS agent.
- In case if a METASYS amalgam separator is built into the unit, GREEN & CLEAN M2 agent must be used.
- In case of DÜRR CAS1 amalgam separator and the DÜRR CS1 separator, OROTOL PLUS must be used.

7.4.2.1 Maintenance, cleaning and decontamination of the CATTANI mini-separator

Anti-foam pastille

i. See the enclosed Instructions for Use of CATTANI Disinfectant Anti-Foam Pastilles

When working with the suction, a turbulent flow is created, where blood, mucus and all kinds of sanitary substances create a lot of foam, which can cause frequent and sudden unwanted stopping of the suction.

Regular use of anti-foam pastilles significantly reduces the incidence of these stops.

Each pastille is coated in a protective film that is soluble in water and guarantees storage and safe handling, even if the product is not classified as dangerous. Do not remove the protective film, it will dissolve in water.

Suction of a small amount of water through the terminal of a big or small suction after placing the pastille inside the sieve of the separation block is sufficient to obtain an immediate effective anti-foaming effect.

If the pastille must be placed in a small space, remove the protective film (gloves are recommended) and break it into two parts by pushing along the pre-marked notch. In order for the sensors to work properly, the film must be cleaned with fine sandpaper. As the liquid passes, the tablet will slowly dissolve and release disinfectants and anti-foams throughout the working day.

Cleaning and decontamination

i. See the enclosed Instructions for Use of PULI-JET PLUS cleaning agent

The separator manufacturer recommends decontamination of the suction system every day after work and performing at least one cleaning wash in the middle of the day. Filling the dispenser: place the bottle in an upright position, preferably on a flat surface. Unscrew the cap and lightly squeeze the bottle in the places marked with the two labels to fill the dispenser to the edge (be careful not to overfill).

Relieve pressure: the excess liquid is returned to the bottle while the exact amount (10 ml) of concentrate remains in the dispenser. Concentrated PULI - JET PLUS after dilution to 0.8% cleans and disinfects, to 0.4% it is only a sanitary cleaning agent. For cleaning and disinfection, dilute two doses (20 ml) of the dispenser in 2.5 l of warm water (50 ° C) once a day after work and absorb it. To clean the system itself, dilute one dose of the dispenser (10 ml) once in the middle of each day. Do not flushing, the proteolytic and disinfectant effect of PULI - JET PLUS manifests itself over time.

7.4.2.2 Cleaning and decontamination of the METASYS MST1 amalgam separator

i. See the enclosed Instructions for Use for GREEN & CLEAN M2 cleaning agent

By double press of the agent dispenser, inject 6 ml of GREEN & CLEAN M2 into the mixing bowl and make up to the mark with tap water. Mix the solution and gradually suck off the solution by big suction through the decontamination openings in the container. After the decontamination, remove the mouthpiece from the container, lift it higher so that the liquid drains from the hose into the collecting pipe and into the separator. Pour the remaining solution that remains in the container into a spittoon bowl and flushing with a small amount of water.

The separator manufacturer recommends to use the GREEN & CLEAN M2 agent **2x** during each working day.

7.4.2.3 Cleaning and decontamination of the DÜRR CAS1 amalgam separator and the DÜRR CS1 separator

i. See the enclosed Instructions for Use of the Orotol Plus agent

Before each decontamination with Orotol Plus, agent, suck-off 1 l of clean cold water through the hose of the big and small suction (use the Oro Cup container for this purpose). In the decontamination with Orotol Plus agent, proceed as follows:

1. Unscrew the Oro Cup container cap
2. pour 2l of cold water into the Oro Cup (to the mark)
3. add the required dose of Orotol Plus disinfectant, i.e. two scoops of the product (one scoop - up to the mark of the lid of Orotol Plus corresponds to 20 ml of solution)
4. screw on the Oro Cup closer
5. mix the disinfectant well with the water in the Oro Cup
6. open the lid of the Oro Cup closer
7. place the Oro Cup vertically (the position is shown on the Oro Cup). This position of the Oro Cup will allow 1 l of the mixed solution to be sucked-off through the suction hoses (0.5 l through the big suction hose and 0.5 l through the small suction hose).
8. using the suction hose adapter attach it to the Oro Cup nozzle
9. pour the rest of the diluted solution (approx. 1 l) from the Oro Cup into a spittoon bowl and flushing it with a small amount of water
10. we recommend decontamination of the suction and waste system with Orotol Plus at least once a day (preferably always at the end of each working day)
11. at the beginning of the next working day, suck-off 1 l of clean cold water through the big and small suction hoses

7.4.3 Cleaning the big and small suction hose sieves

Under the back cover of the spittoon block there are sieves for capturing the sucked gross particles. The sieves must be removed, flushing under running water and put back.

i. We recommend cleaning at least once a day.

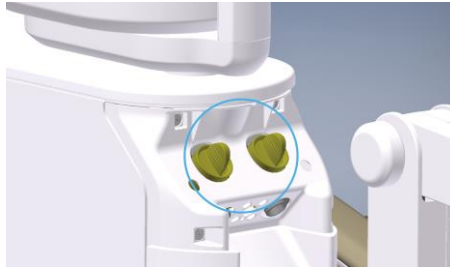

7.4.4 Cleaning and decontamination the Dürr spittoon valve (if installed)

For cleaning and decontamination it is necessary:

Material-compatible, non-foaming disinfectant / cleaning agent that is approved by the manufacturer Dürr Dental, for example Orotol plus or Orotol Ultra.

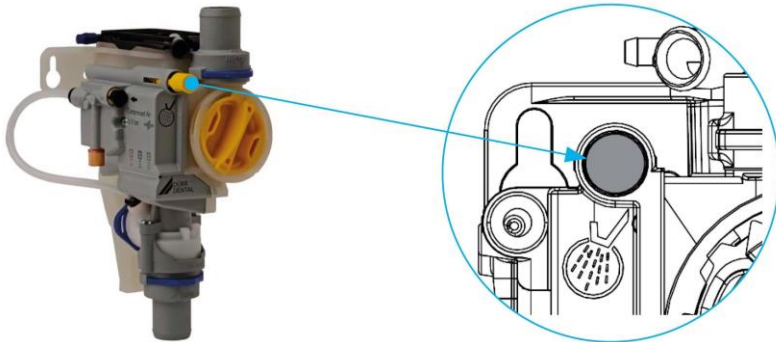

Cleaning button

Procedure:

1. Start flushing of the spittoon bowl.
2. Press and hold the yellow cleaning button on the control panel until the spittoon bowl is flushing.
3. Pour the disinfectant solution into the spittoon bowl and at the same time press the valve cleaning button on the control panel until the disinfectant solution is sucked-off.

Monthly maintenance:

1. Press the valve purge button to empty the valve collection container.
2. Clean the yellow gross filter or replace it if necessary.

The yellow gross particle filter prevents big solid particles from entering the suction system.

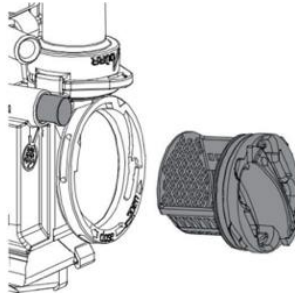

Failure or damage to the device due to the use of incorrect products may void the warranty



- Do not use any foaming agents, such as cleaning agents intended for households.
- Do not use abrasive cleaning agents.
- Do not use any agents containing chlorine.
- Do not use any solvents such as acetone.

7.4.5 Cleaning and decontamination of the spittoon bowl

Regularly check the condition of the sieve, which traps gross dirt in the spittoon bowl, and clean it if necessary.

Decontamination of the spittoon bowl should be performed at least once a day (for example after completion of the work) with SAVO Prim agent in a 1% concentration in a volume of at least 200 ml of solution by pouring into the spittoon bowl.

7.4.9 Cleaning, disinfection and decontamination of other parts of the dental unit

- Clean the surface of the unit, tablet and chair upholstery with a damp cloth
- Recommended agent: Incidin™ Foam - spray (HENKEL - ECOLAB).
- Clean regularly and in case of any contamination



Upholstered parts must not be cleaned with products that contain more than 10% alcohol and that disrupt the structure of the leatherette, such as acetone, trichlorine perchlorine, abrasive cleaners, polishing lacquers.

Other parts must not be cleaned with agents that damage the structure of the paint and plastics (phenol- and aldehyde-based agents).

Clean at least once a day (depending on the version):

- suction sieves in the spittoon block
- sieve at the inlet to the amalgam separator
- saliva ejector sieve
- small and big suction sieves
- spittoon bowl sieve



7.4.10 Instruments and nozzles

Cleaning, disinfection and sterilization of instruments and their nozzles must be performed according to the instructions of their manufacturer, which is supplied with the instrument.

i. The manufacturer is not liable for damage caused by the use of disinfectants and cleaning agents other than those recommended.

8 Warranty, service and disposal of goods

8.1 Service

In the event of a fault, contact your service technician or dealer.

8.1.1 Service inspections during the warranty period

It is recommended to perform a regular service inspection every 3 months.

The service inspection is focused on checking of:

- input filters,
- suction system,
- waste hose,
- all media,
- the correct use and maintenance of the unit and instruments; and
- mechanical parts of the chair.

i. The service technician is obliged to confirm the performed inspection in the Warranty Certificate.

8.1.2 Service inspections after the warranty period

It is recommended to perform a regular service inspection every 6 months.

Post-warranty service inspection is focused on checking of:

- water and air filters,
- integrity of electrical parts and installation,
- functional parts of a dental unit and
- adjustment of working water and air pressures.

8.2 Electrical safety inspection

It is performed according to the regulations of the country in which the unit is installed.

8.3 Warranty

The manufacturer provides a warranty for the product according to the Warranty Certificate.

The risk of damage to the goods passes from the seller to the buyer at the time of delivery of the goods to the first carrier for transport to the buyer, or at the time of taking over the goods directly by the buyer.

When taking over the product for use, the buyer shall be obliged to write out the warranty form and send it back to the manufacturer.



Faults caused by careless operation or disregard of the instructions in the Operating Instructions will not be recognized as the subject of a warranty claim

The manufacturer reserves the right to make changes as part of product innovation.

8.4 Disposal of the device

Part of the unit	Basic material	Recyclable material	Landfill waste	Hazardous waste
Frame and covers				
• metal	aluminium	✓		
• plastics	PUR PVC PA, ABS Fibre-glass Other plastics	✓ ✓ ✓	✓	✓
• rubber			✓	
• ceramics			✓	
Instruments				
			✓	
Electronics				
		✓		
Cables				
	Copper	✓		
Transformer				
		✓		
Amalgam separator				
	Filters			✓
	Collection container with amalgam			✓
Cover				
	Wood	✓		
	Cardboard	✓		
	Paper	✓		
	PUR	✓	✓	

Do not dispose of in municipal waste!



Waste can be taken back at designated places, e.g. electrical waste.

When disposing the dental unit, it is necessary to observe legislation of the specific country. It is necessary to decontaminate the unit before disassembly - clean the surface, clean the suction and waste system, remove the amalgam from the separator and hand it over to the collection service. It is advisable to entrust the liquidation to a professional company

9 Packaging content, packing and transport

9.1 Packaging content

Basic equipment:

dental chair	cuspidor block with sister' arm
doctor's panel with pantograph / CART - trolley	spittoon bowl
	lamp
	lamp pantograph holder
	foot control
	side table
	instruments

Supporting documentation:

Instructions for use
 Warranty Certificate
 instructions from suppliers
 assembling sheet
 registration form

According to the order:

hand-rest right
 side table
 monitor arm and monitor
 Intra-oral camera

9.2 Transport conditions

- transport in covered vehicles
- stack according to the instructions on the package
- securing against movement
- packages with units must not be spontaneously tipped or lowered

Parameter	Value
Ambient temperature	-25 - 50 °C
Relative humidity	5 - 95 % non-condensing humidity
Atmospheric pressure	700 – 1060 hPa

9.3 Storage conditions

- storage in a dry, covered place without sudden changes in temperature
- stack according to the instructions on the package
- The units must not be stored together with chemicals

Parameter	Value
Ambient temperature	-25 - 50 °C
Relative humidity	5 - 95 % non-condensing humidity
Atmospheric pressure	700 – 1060 hPa

10 Electromagnetic compatibility requirements according to EN 60601-1-2



Use of accessories other than those specified in the Instructions for Use of the dental unit may cause increased electromagnetic radiation or reduced electromagnetic immunity and may cause the apparatus to malfunction.



The portable radio frequency communication apparatus must not be used closer than 30 cm from any part of the dental unit. Otherwise, the functionality of this apparatuses may deteriorate

10.1 Electromagnetic radiation

Table 10. 1

Measuring of interfering RF radiation	Concordance	Electromagnetic environment
High-frequency radiation according to CISPR11	Group 1	The dental unit uses high-frequency energy only for its function. Its high-frequency radiation is very low and is unlikely to cause interference to nearby electrical devices.
High-frequency radiation according to CISPR11	Class B	The dental unit is designed for use in all environments, including residential areas, and can be connected directly to a public low-voltage distribution network.
Radiation limits of harmonic current components EN 61000-3-2	Class A	
Limitation of voltage changes, voltage fluctuations and flicker in public low-voltage distribution networks EN 61000-3-3	Concords	

10.2 Electromagnetic resistance

The dental unit is designed for use in an electromagnetic environment that meets the requirements in Table 19.2. The customer or the user must ensure that the dental unit is operated in such an environment.

Table 10. 2

Resistance test	Test level according to EN 60601	Concordance	Electromagnetic environment
Resistance to electrostatic discharge according to EN 61000-4-2	Contact discharge ± 6 kV	Contact discharge ± 6 kV	Floors should be wooden, concrete or made of ceramic materials. If floors are covered with synthetic material, the air relative humidity should be at least 30%.
	Air discharge ± 8 kV	Air discharge ± 8 kV	

Resistance to fast electrical transients / impulse groups according to EN 61000-4-4	±2 kV for power cables ±1 kV for power cables	±2 kV for power cables ±1 kV for power cables	The quality of the power supply should correspond to typical commercial or hospital environment
Resistance to impact impulses according to EN 61000-4-5	±1 kV symmetrical voltage ±2 kV analogous voltage	±1 kV symmetrical voltage ±2 kV analogous voltage	The quality of the power supply should correspond to typical commercial or hospital environment
Resistance to magnetic field with mains frequency according to EN 61000-4-8	3 A/m	3 A/m	Mains frequency magnetic fields should not exceed the typical value for commercial and hospital environments
Resistance to short-term voltage drops, short interruptions and voltage fluctuations according to EN 61000-4-11	< 5% UT (> 95% short-term drop in UT over 0.5 period) < 40% UT (> 60% short-term drop in UT over 5 periods) < 70% UT (> 30% short-term drop in UT over 25 periods) < 5% UT (> 95% short-term drop in UT over 5 period)	< 5% UT (> 95% short-term drop in UT over 0.5 period) < 40% UT (> 60% short-term drop in UT over 5 periods) < 70% UT (> 30% short-term drop in UT over 25 periods) < 5% UT (> 95% short-term drop in UT over 5 period)	The quality of the power supply should correspond to typical commercial or hospital environment If the user needs continuous operation during a power outage, it is recommended that the unit be connected from a backup source.
Resistance to interference induced by high-frequency fields, propagated by lines according to EN 61000-4-6	3 Veff 150 kHz to 80 MHz	3 Veff	Portable and mobile high-frequency communication devices should not be used at a distance less than the recommended distance calculated according to the relevant equation for the transmission frequency.
Resistance to radiated high-frequency electromagnetic field according to EN 61000-4-3	3 V/m 80 MHz to 2.5 GHz	3 V/m	Recommended minimum distances: $d=1.167 \sqrt{P}$ 150 kHz to 80 MHz $d=1.167 \sqrt{P}$ 80 MHz to 800 MHz $d=2.333 \sqrt{P}$ 800 MHz to 2.5 GHz P [W] - rated maximum output power d [m] - recommended protection distance

The field strength from fixed transmitters should be below the appropriate level in each frequency band.

Around the device marked with the symbol



interference may occur.

i. The band 80 MHz to 800 MHz applies to the 80 MHz frequency and the band 800 MHz to 2.5 GHz applies to the 800 MHz frequency



These guidelines may not be applicable in all situations.
The propagation of electromagnetic fields is affected by absorption and reflections from buildings, objects and people.

The field strength of stationary transmitters such as base stations for cordless telephones, mobile radio communication apparatuses, amateur radio stations, radio and television transmitters, etc. is not possible to theoretically determine in advance. To evaluate the electromagnetic environment from the stationary transmitters point of view, it is appropriate to consider measuring electromagnetic fields. If the measured intensity of the electromagnetic field at the location of the dental unit exceeds the above levels, its correct function must be verified. If abnormal behaviour of the dental unit occurs, the unit must be installed at some other place.

In the range from 150 KHz to 80 MHz, the field strength should be less than 3 V / m.

10.3 Recommended safety distances between portable high-frequency communication devices and the dental unit

The dental unit is designed for use in an electromagnetic environment in which radiated RF interference is under control. The customer or the user can prevent electromagnetic interference by observing the minimum distances between the portable high-frequency communication device and the dental unit according to the Table 10.3.

Table 10.3

Rated maximum output power of the transmitter P[W]	Protective distance depending on the frequency of the transmitter d[m]		
	150 kHz to 80 MHz $d=1.167 \sqrt{P}$	80 MHz to 800 MHz $d=1.167 \sqrt{P}$	800 MHz to 2.5 GHz $d=2.333 \sqrt{P}$
0.01	0.117	0.117	0.233
0.1	0.369	0.369	0.738
1	1.167	1.167	2.333
10	3.69	3.69	7.377
100	11.67	11.67	23.33

P [W] - rated maximum output power

d [m] - recommended protective distance

For transmitters with a maximum power not listed in the table, the distance is calculated according to the formula given in the table at the appropriate frequency.

i. The band 80 MHz to 800 MHz applies to the 80 MHz frequency and the band 800 MHz to 2.5 GHz applies to the 800 MHz frequency



These guidelines may not be applicable in all situations.
The propagation of electromagnetic fields is affected by absorption and reflections from buildings, objects and people.