

CHIRANA – DENTAL  
Vrbovská cesta 17  
921 01 Piešťany  
SLOVAKIA

## **INSTRUCTIONS FOR USE**

**Dental unit**

**DIPLOMAT ADEPT DA 130, DA 170**



**CONTENTS**

1	PURPOSE AND USE .....	3
2	PRODUCT DESCRIPTION .....	4
3	TECHNICAL DATA .....	4
4	DESCRIPTION OF THE DENTAL UNIT .....	5
4.1	Data plate.....	6
5	PRE-INSTALLATION REQUIREMENTS.....	7
5.1	Environmental conditions .....	7
5.2	Requirements for the installation of media.....	7
5.3	Floor.....	8
5.4	Environment.....	8
6	INSTALLATION AND ASSEMBLY .....	8
7	PUTTING THE UNIT INTO OPERATION .....	9
8	PRODUCT OPERATION .....	10
8.1	Control panel with instruments .....	10
8.1.1	Description of the buttons .....	11
8.1.2	Setting of the water amount.....	14
8.1.3	Button of the brake of the control panel .....	15
8.1.4	Fitting of the tray of the tray table .....	15
8.1.5	Operation of individual instruments.....	15
8.2	Foot controller .....	18
8.3	Spittoon block.....	20
8.3.1	Assistant table .....	21
8.3.2	Holder of the saliva ejector .....	22
8.3.3	Equipment of the spittoon block .....	22
8.4	Dental operating light .....	23
8.5	Completion of work .....	23
9	PRODUCT MAINTENANCE.....	23
10	CLEANING, DISINFECTING AND DECONTAMINATION.....	24
10.1	Disinfecting of internal distributions of Instruments .....	24
10.2	Decontamination of the spittoon bowl .....	24
10.3	Cleaning and decontamination of the saliva ejector .....	24
10.4	Cleaning and decontamination of the big and small aspirator.....	25
11	DISPOSAL OF THE EQUIPMENT .....	26
12	REPAIR SERVICE.....	27
13	THE CONTENTS OF THE PACKAGING.....	27
14	GUARANTEE .....	27
	ANNEX NO.1 DENTAL OPERATING LIGHT SIRIUS .....	28

**1 PURPOSE AND USE**

This manual describes how to use the **DIPLOMAT ADEPT DA 130, DA 170** dental units. Please read this manual thoroughly before attempting to operate the unit.

The unit is allowed to be operated only by the dentists who has been made familiar with the present manual and dental applications that can be done by means of the dental unit. In order for you to be satisfied with the dental unit, the following must be observed: Installation, setting and/or modifications must be made by the qualified authorized service personnel of an organization that has licence for such activity. Conditions for the use of media and installation given in the **DIPLOMAT ADEPT DA 130, DA 170 Instructions for Use** must be met, too.



**DIPLOMAT ADEPT DA 130**



**DIPLOMAT ADEPT DA 170**

## 2 PRODUCT DESCRIPTION

The **DIPLOMAT DA 130, DA 170** dental units are designed as a stationary one. Chair of DIPLOMAT series and/or other chair, the integral part of which is a foot controller, can be used with the unit. Control panel pantograph with the control panel and instruments, and light pantograph with the dental operating light are fitted at the upper part of the bearing pillar of the spittoon block. The instruments are controlled by the foot controller, except for the syringe, saliva ejector, big and small aspirator. On the front surface of the control panel is a foil keyboard or a glass touch keyboard with a design motif, display and negatoscope. The handle serves for re-positioning of the control panel. X-ray images are attached to the negatoscope by means of a clamp furnished. The spittoon block is delivered in various versions with a saliva ejector or with assistant arm with big and small aspirator. The glass bowl, bowl flushing tube and cup filling tube are detachable. Suction handpieces of the small and big aspirator are detachable, capable of being disinfected and sterilized. Handpieces of the saliva ejector are for single use. Side table with a side dish fixed to the arm of the light pantograph and monitor arm with LCD monitor are installed as an option upon order. The **DIPLOMAT DA 130, DA 170** dental units are always equipped on the control panel with a syringe.

### The control panel can be fitted with the following instruments:

max. 4 rotary instruments	min. 1 syringe
max. 5 instruments with light	1 scaler
max. 3 turbines	1 polymerization lamp (led)
max. 4 micromotors (max. 3 DC motor, max. 2xMX motor)	1 blaster

### Note

Optional equipment and supplementary equipment (see the current price list).

## 3 TECHNICAL DATA

Supply voltage	230V ± 10%
Frequency	50 Hz ± 2 %
Max. power input at 230V/50 Hz	400 VA + 10%
Input pressure of air	from 0,45 to 0,8 MPa
Input pressure of water	from 0,3 to 0,6 MPa
Dental unit weight	74 kg ± 5 kg
Type of protection against electric shock	Class I equipment
Degree of protection against electric shock	applied parts of B type
Temperature of water for cup	36 ± 5 °C (with heater fitted)
Max. loading capacity of the tray table	1,5 kg
Max. loading capacity of the side table	3 kg



To eliminate risk of electric shock, the present equipment must be connected to the supply mains with protective earthing.

Operation mode is continuous with intermittent loading, corresponding to the common dental practice.

4 DESCRIPTION OF THE DENTAL UNIT

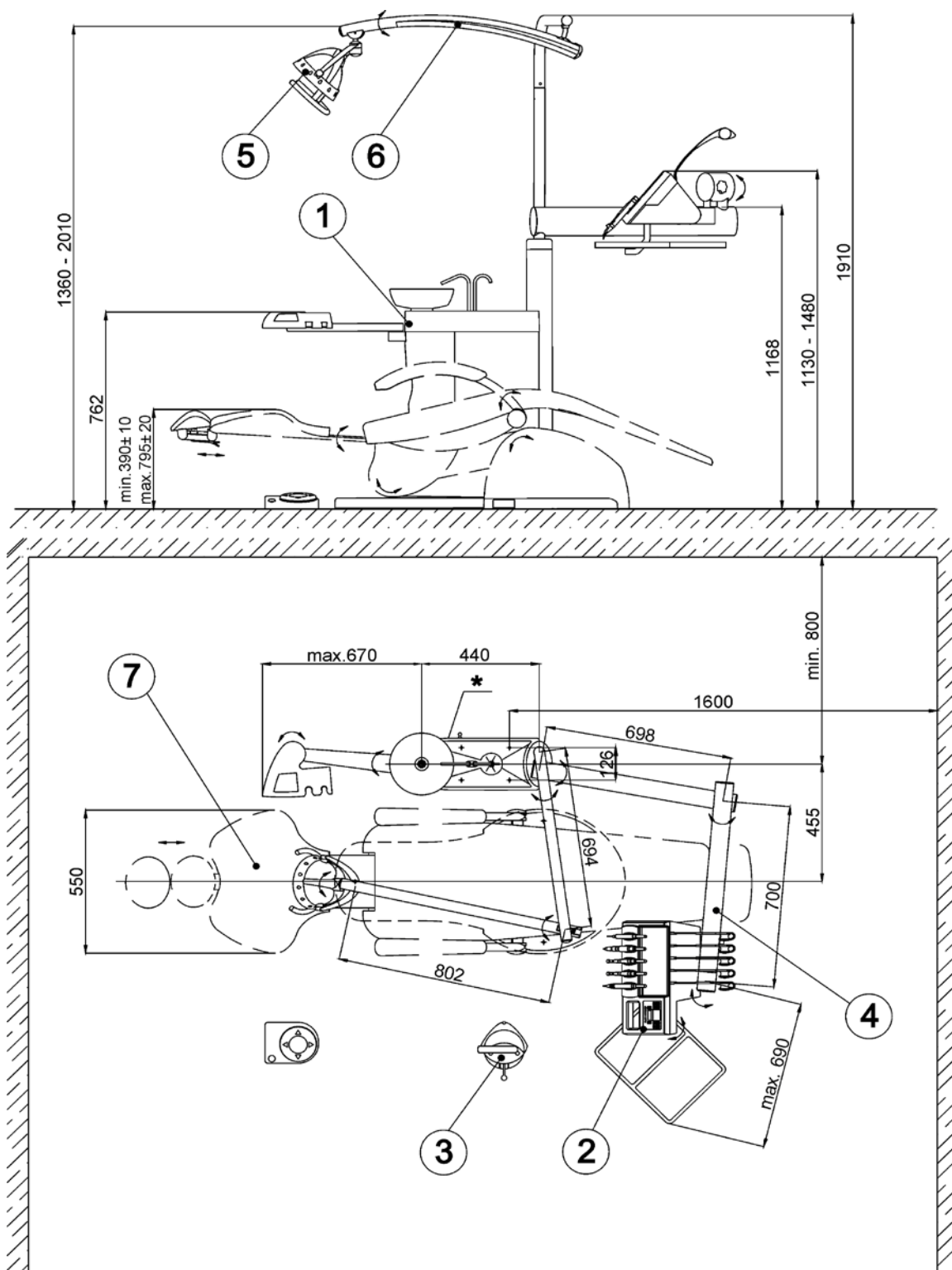

- 1. Spittoon block with assistant arm
- 2. Control panel
- 3. Foot controller
- 4. Pantograph of the control panel
- 5. Dental operating light
- 6. Pantograph of the light
- 7. Dental chair of DIPLOMAT series

\* - main switch, located on the outer side of the spittoon block

4.1 Data plate

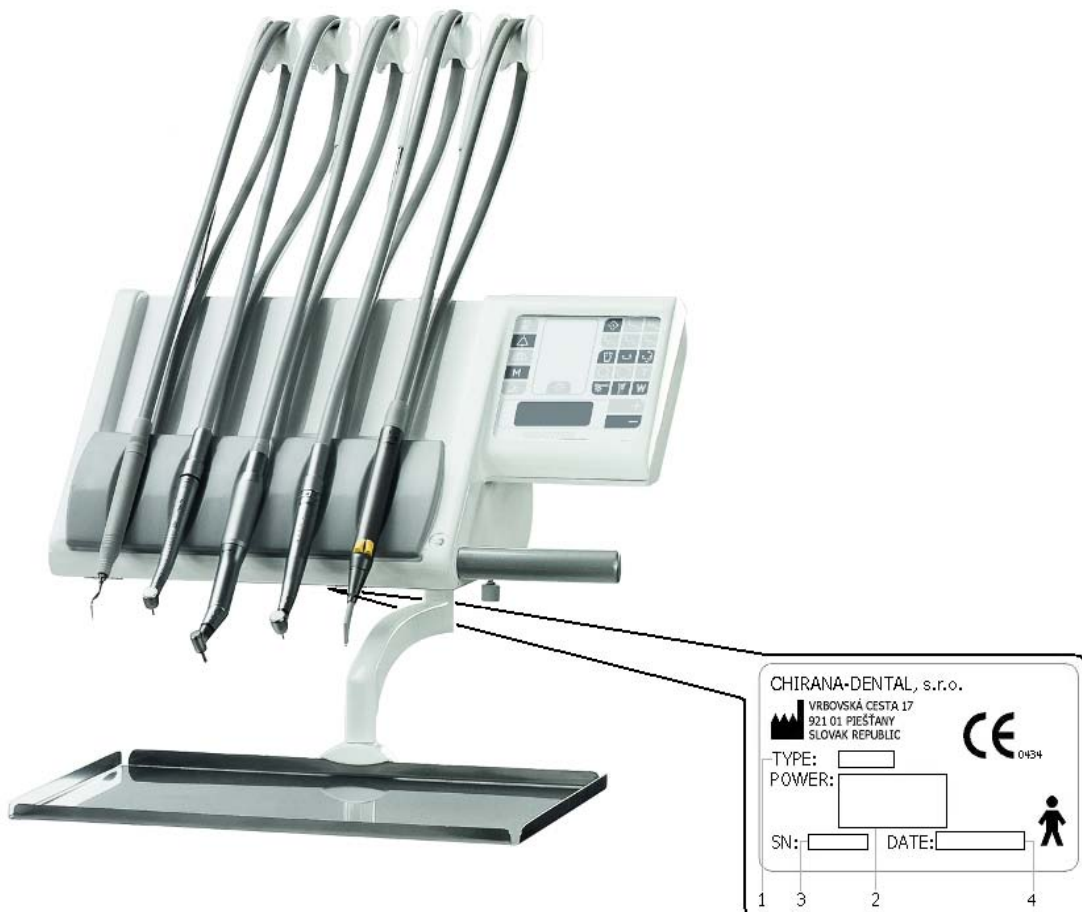

- 1 – designation of the unit type
- 2 – basic electrical parameters
- 3 – serial number
- 4 – production date

## **5 PRE-INSTALLATION REQUIREMENTS**

### **5.1 Environmental conditions**

Not to be installed in the premises with explosion hazard!

### **5.2 Requirements for the installation of media**

#### **Water**

Drinkable water with input pressure of **0,3 MPa to 0,6 MPa** with the flowrate of **min.4 l/min.**, without particles bigger than **50 µm**, which might clog the small cross sections of the pipes of the dental unit, must be used. If the water contains particles bigger than **50 µm**, there must be introduced **50 µm** advance filter /strainer.

#### **Cooling of instruments with water from the central distribution**

There must be introduced **5 µm** filter. **If the water contains more than 50 mg CaO/l, or 36 mg MgO/l**, there must be introduced water treatment device connected to the input of the water distribution. Hard water may even cause the unit not to function. Water treatment device is introduced if distilled water is not used. The distribution after the filter must be made of Cu, and/or PE tube. A suitable certified closing valve must be introduced into the central distribution of water for the unit! In installation it is necessary to install a device to prevent the backflow at the point of the connection to the supply of municipal tap water. The said device is not part of the dental unit.

#### **Air**

Supply of at least **55 l/min.** of air at the pressure of **0,45 to 0,8 MPa**, oilless, clean and dry, must be ensured.

#### **Suction (in the event of the version of the spittoon block with big and small aspirator)**

Static vacuum must be within the range of min. **0,005 MPa** (50 mbar) to max. **0,02 MPa** (200 mbar), measured at the installed position. When the static vacuum is higher than 0,02 MPa, a suction calibration (regulating) valve should be introduced in the suction branch to restrict the max. vacuum to 0,02 MPa. The said regulating valve is not part of the dental unit. The suction unit must produce the flowrate of at least **450l/min.**, measured at the installed position.

#### **Waste**

The waste /drain/ branch must have continuous slope of min. **1%** with minimum flowrate of **10l/min.** and must be free of sharp bends and conditions that might cause backflow. **Do not use the same waste branch with another dental unit or a basin!** It is allowed to use tubes made of polypropylene or cured polyethylene.



#### **Caution**

Pre-installation and installation must be performed according to the applicable standards of the particular country and in accordance with the valid documentation of the manufacturer, which is owned by each authorized representative of Chirana Dental s.r.o.

**Note**

If the regulations of the country in which the installation is carried out require an amalgam catcher, the dental unit with the spittoon block without the amalgam catcher must be connected to an external amalgam catcher. Installation of the external amalgam catcher must be carried out according to the instructions of its manufacturer!

**Recommended mains fuse rating**

Recommended rating of the fuse of the supply main is 10A (in the event of circuit breaker – circuit breaker with switching-off characteristic of B type). No other equipment should be connected to the supply main in question! Max. power input of the dental unit is 400VA. The supply main must comply with the respective national standard. Pre-installation requirements having been met, assembly and installation of the dental unit is carried out and it is connected to the media.

**Recommendation**

Unless national standard stipulates otherwise, the manufacturer recommends to use current protective switch with the sensitivity of 30mA and instantaneous time of switching-off.

**5.3 Floor**

The floor must have a concrete foundation of at least 100mm thickness. The slope of the floor shall not exceed 1%. The use of antistatic floor is recommended.

**5.4 Environment**

ambient temperature range	from +10°C	to +40°C
relative humidity range	from 30%	to 75 %
atmospheric pressure range	from 700 hPa	to 1060 hPa

**6 INSTALLATION AND ASSEMBLY****Unpacking the unit and inspection of the delivery**

Inspect the transport packages for damage. If a defect of the transport package is found, do not open the consignment, and report the defect to the forwarding agent or seller immediately. If the consignment is intact, carefully open the package and unpack individual parts of the dental unit. Check the completeness of the delivery according to the **Packing List**. If the unit is equipped with a touch keyboard, take care of the glass surface in handling.



## 7 PUTTING THE UNIT INTO OPERATION

1. switch on the compressor and let it get pressurized
2. open the central water supply
3. turn on the suction unit (if the spittoon block is fitted with the big and small aspirator)
4. turn on the main switch located on the cover of the spittoon block – position I, the indicator light of the main switch goes on. The following message is displayed:

DENTAL UNIT READY FOR WORK
-------------------------------

Thus indicating the readiness of the unit for operation. The unit is connected to water and air from distributions. After approx. 5s the unit is ready to work. If the dental unit is equipped with electrical water heater, it is necessary to wait for approx. 10 min. for the water to be warmed up to the desired temperature. In turning the unit on, no instruments should be taken, the foot controller should be in the rest position and the buttons of the keyboards should not be depressed.



### Caution

When lifting the back rest of the chair, the arms and the assistant table must not be in the position above the back rest.

Besides the saliva ejector, small and big aspirator – according to the model – polymerization lamp, syringe (on the assistant table) and syringe (on the control panel and on the assistant table) only one instrument can be used (taken) simultaneously! Not observing of the condition above is indicated on the display by the following message:

DENTAL UNIT INSTRUMENT ERROR
---------------------------------

8 PRODUCT OPERATION

8.1 Control panel with instruments



foil keyboard



foil keyboard

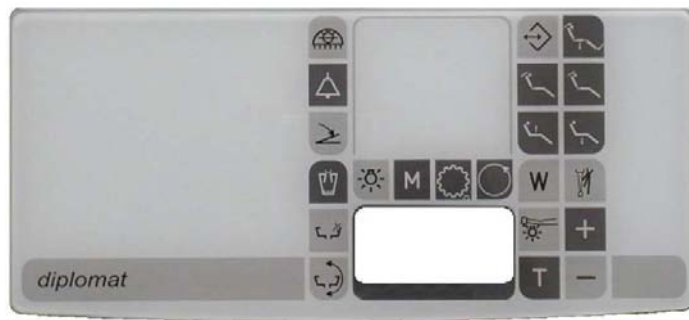

glass keyboard

















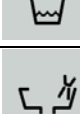

glass keyboard



**Note**



The display is legible in every working position of the dentist (both is sitting and standing).

Symbol	Description	Symbol	Description	Symbol	Description
	negatoscope illumination	<b>W</b>	adjustment of cooling water amount		rotation of the spittoon bowl (not used for DA 170 and DA 130)
	instrument cooling	<b>P1</b> <b>P2</b>	changing-over of the program sets (not used)		switch to move the chair up
	reversing of the rotations of the micromotor		main light control		switch to move the chair down
	cup filling		additional button (e.g. door opening)		switch to move the rest forward
	spittoon bowl flushing	<b>M</b>	selection of the mode for the activity of MX motor		switch to move the rest backward
	illumination of instruments	<b>T</b>	setting of the torque for MX motor		writing-in and recalling of program positions (valid only for the chairs with programming)
<b>+</b>	button to increase parameters		Changing-over of the function of the foot controller (analogue - ON/OFF)		automatic setting of the starting (getting-on) position
<b>-</b>	button to decrease parameters		change of the transmission ratio of the instrument head		

**8.1.1 Description of the symbols**

To activate the function the touch on the point of a chosen symbol is enough. The selection of the chosen function is indicated beside the display also by means of a short beep. With all controllable values their informative value is represented by a bargraph at the bottom part of the display. Maximum of the bar corresponds to 100 % set value.

 **Button – illumination negatoscope**

Touch on to the symbol to turn the negatoscope illumination on. Another touch the illumination off, press it again. To control the intensity of the negatoscope, press the symbol  and the symbols PLUS and MINUS simultaneously with the negatoscope turned on. After turning the negatoscope on and keeping the finger on  depressed for more than **4s**, the negatoscope luminance will start to increase up to the maximum. After the maximum luminance has been reached, the luminance will decrease to the minimum and increase gradually.

 **Instrument cooling**

It is possible to switch the instrument cooling on touch on to the , for micromotor and turbine, while the switched-on condition is indicated by going the symbol "S" or "W" on the display. When the instrument has been returned to the basic position, the current setting of the instrument cooling is saved.

The following 3 conditions of cooling are possible:

- "S" – spray cooling
- "W" – water cooling
- " \_ " – cooling off



### Reversing of the rotation of the micromotor

It serves to change the direction of the revolutions of the micromotor, setting of the ENDO function for the ultrasonic scaler and setting of AFT (auto-forward time) for MX motor.



### Cup filling

To let the patient cup fill for the set time, keep the symbol depressed for more than **0,2 s**. To set the filling time up to the moment the symbol has been released, keep the symbol depressed for more than **4s**. To interrupt the cup filling during the cup filling time, press the button for min. **0,2s**. Max. programmed cup filling time is **25s**.



### Bowl flushing

To start the flushing of the spittoon bowl for the set time, keep the button depressed for more than **0,2s**. To set the spittoon bowl flushing time up to the moment the symbol has been released, keep the button depressed for more than **4s**. To interrupt the bowl flushing during the bowl flushing time, press the symbol for min. **0,2s**. Max. programmed bowl flushing time is **40s**.



### Illumination of instruments

Touch on to the symbol to turn the illumination of the rotary instruments (turbine, micromotor) on and off. Touch is possible to modify the instrument that has been taken. When the instrument illumination is turned on, "L" is displayed. The instrument illumination goes on after putting the instrument into operation by moving the lever of the foot controller to the right. The instrument illumination goes off automatically after 10s has elapsed from the end of the use of the instrument. After the instrument has been replaced to the basic position, the instrument illumination goes off.

**Plus and minus**

To increase (decrease) the parameter being set up to the max. value, press by means of a short touch repeatedly. Touch and by keeping the symbol depressed, after 1s has elapsed, the parameter in question is increased (decreased) automatically up to the maximum (minimum) value.

These symbols serve to:

- the micromotor speed (revolutions)
- the output when using the scaler
- negatoscope illuminance (illumination intensity), with the negatoscope turned on
- main light illuminance
- flowrate of cooling water
- setting of the torque for MX motor

**Water**

According to the version of the dental unit it is possible to adjust the flowrate of cooling water, see cl.8.1.2. If the unit is not fitted with the proportional valve, then it is not displayed.

**P1/P2**

The symbol serves for the selection of programs – it is not used.

**Control of the main light**

The symbol serves to turn the main dental light off. Touch to change-over between the three conditions – lower illuminance, higher illuminance, light turned off. At the higher illuminance it is possible to control the illuminance by simultaneous touch on to the symbols and the symbol PLUS or MINUS, namely so that in changing-over from the lower illuminance to the higher one keep the symbol depressed and increase or decrease the illuminance of the dental light by means of the symbols PLUS and MINUS. It is possible to control the illuminance also by keeping the finger on depressed for more than 4s when changed-over to the higher illuminance.

**Supplementary button (e.g. door opening)****Selection of the mode of activity for MX motor**

The symbol serves for the selection of the mode of activity for the MX micromotor, while the selected mode is displayed: "**MX N**" – normal mode of activity, "**MX R**" auto-reverse mode, "**MX F**" auto-forward mode.

**Setting of the torque for MX motor**

Setting of the limit torque for the MX motor. After touch on to the symbol, the limit torque is set by means of the PLUS, MINUS symbols. The mode of the setting of the limit torque is indicated by means of the symbol "!" by the symbol "T" ("**T! xxx,xxxNcm**"). To finish the setting of the torque, press the symbol again; the message "**T=xxx, xxxNcm**" is displayed.



### Changing-over of the function of the foot controller (analogue- ON/OFF)

The symbol serves to change-over the mode of the foot controller. It is possible to change-over between the mode of proportional control and "on /off" mode.



### Change of the transmission ratio of the instrument head

Touch on to the symbol it is possible to choose one of the following transmission ratios: 1:1, 2:1, 7:1, 10:1, 20:1, 100:1, 1:5, 1:4, 1:2.



### Rotation of the spittoon bowl

**(Not used in DA170 and DA130 dental units)**

In the event that the spittoon block is equipped with rotary spittoon bowl, the bowl can be turned by pressing the symbol. To put the bowl into motion, press the symbol. To stop the bowl, press the symbol again. The bowl stops automatically in the extreme positions.



### Automatic setting of the starting (getting-on) position

If all the instruments are replaced and touch to select the symbol, the getting-on position is recalled and also dental light is switched off and the bowl is flushed. If an instrument is taken, only getting-on position is recalled.

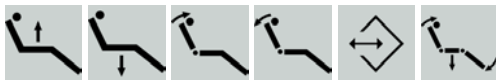

control of the chair

## 8.1.2 Setting of the water amount

According to the version of the dental unit:

- The amount of cooling water for all instruments, except for the syringe, can be adjusted by means of the needle valve located on the bottom side of the control panel. When the valve has been turned fully clockwise, the water supply stops.
- In the event that the unit is equipped with a proportional valve, it is possible to adjust the amount of cooling water by pressing the button **w** after the respective instrument has been taken. After the selection **w** has been pressed, the message on the display is changed from "**W=xxx%**" to "**W! xxx%**" and then the amount of cooling water can be adjusted by means of the plus, minus symbols. To finish the setting of the flowrate, press the symbol **w** again; the message "**W=xxx%**" is displayed. The setting of the water amount is saved automatically after the instrument has been replaced to the basic position.

**8.1.3 Button of the brake of the control panel**

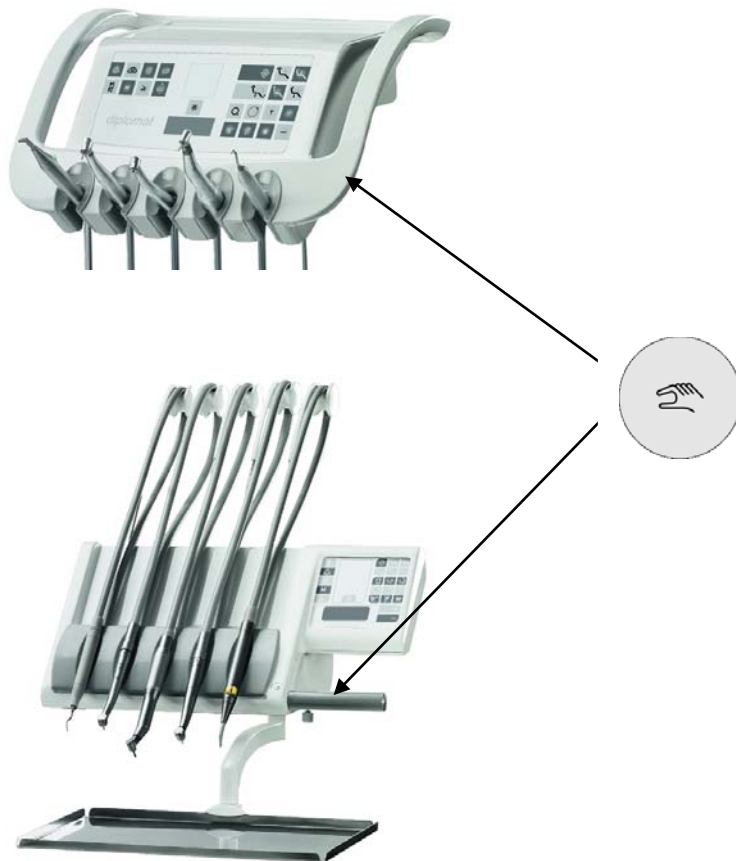

By pressing the button the control panel is unbraked and it is possible to move it freely in vertical direction. After it has been set in the desired position and the button has been released, the control panel gets braked.

**8.1.4 Fitting of the tray of the tray table**

The tray table with the tray is installed for DA 170 dental unit. The tray of the tray table is made of stainless steel and it is possible to remove it by pulling it out of the holder in the direction of the arrow (see the illustration).

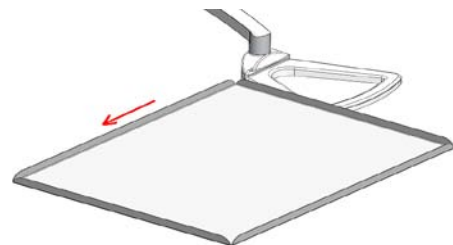

**8.1.5 Operation of individual instruments**

**Control panel**

In addition to mentioned below, it is necessary to follow the instructions of the manufacturers of instruments and accessories.

**Syringe**

It is ready to operate already in the holder. For air blowing press the right lever, for water rinsing press the left one and to create water mist (spray) press both levers simultaneously.

## Turbine

### Display for the turbine

TURBINE1	W L W=xxx%
	100%

After the turbine has been taken, the data on its setting is displayed. Its meaning is as follows:

- **TURBINE1** – turbine taken, (**TURBINE2, TURBINE3, TURBINE4**)
- **W** – water cooling turned on, **S** – spray cooling turned on; if the symbol is not lit, the cooling is turned off
- **L** – instrument illumination turned on; if the symbol is not lit, the instrument illumination is turned off
- **W=xxx%** - amount of cooling water (only if proportional valve is fitted)

To activate the turbine, take it and move the foot controller lever to the right. To stop the activity, return the lever of the foot controller to the starting position. After the activity has been finished, it is recommended to use the CHIPBLOWER function. It is not possible to control the revolutions for the turbine.

## Micromotor

### Display for the micromotor

M2 C2	<	W L W=xxx%	A
P = xxx, xx%		xxxxxx	R P M
T= xxx, xxxNcm		R=xxx	: x

After the micromotor has been taken, the data on its setting is displayed. Its meaning is as follows:

- **M2** - micromotor taken (**M1, M3**)
- **C2** – type of the micromotor taken **C2 - MC2, C3 - MC3, MM** - other type
- **<** - informs about the counter-clockwise revolutions of the micromotor; if the symbol is not lit, the revolutions are clockwise
- **W** – water cooling turned on, **S** – spray cooling turned on; if the symbol is not lit, the cooling is turned off
- **L** - instrument illumination turned on; if the symbol is not lit, the instrument illumination is turned off
- **W=xxx%** - amount of cooling water (only if proportional valve is fitted)
- **A** – analogue control of the output, **O** – step control of the output from the foot controller
- **P=xxx,xx%** - micromotor output
- **xxxxxxRPM** – informative revolutions /speed/ of the micromotor
- **T=xxx,xxxNcm** – maximum torque
- **R=xxx:xx** – transmission ratio

To activate the micromotor, take it and move the foot controller lever to the right. When the lever is moved to the extreme position, the micromotor has the output that is displayed. To stop the activity, move the foot controller lever to the starting position. After the activity has been finished, it is recommended to use the CHIPBLOWER function. The output of the micromotor can be adjusted by means of the PLUS, MINUS buttons within the range of 0-100%. The change of the direction of the revolutions is made by pressing the REVERSE button on the keyboard or by keeping the spray button on the foot controller depressed for more than 2s and less than 10s.



If the analogue control of the output is turned on, by moving the lever of the foot controller it is possible to change the micromotor output continuously from 0 up to the value set on the display.

## Micromotor MX

### *Display for the MX micromotor*

M4x F # W L W =xxx% 0 N = xxxxxx RPM xxx, xx% T = xxx, xxxNcm R=xxx : x AFT = 3,5s
---

After the micromotor has been taken, the data on its setting is displayed. Its meaning is as follows:

- **M4X** - MX micromotor taken (**M3X**)
- **F** – mode of work of the micromotor: **F** - auto-forward , **N** - normal , **R** - auto-reverse
- **#** - in the event of the modes of auto-forward and auto-reverse, the symbol # is displayed. In the event of normal mode, the symbol < indicates counter-clockwise revolutions of the micromotor; if the symbol is not lit, the revolutions are clockwise
- **W** – water cooling turned on, **S** – spray cooling turned on; if the symbol is not lit, the cooling is turned off
- **L** - instrument illumination turned on; if the symbol is not lit, the instrument illumination is turned off
- **W=xxx%** - amount of cooling water (only if proportional valve is fitted)
- **O** – step control of the output from the foot controller, **A** – analogue control of the output
- **N= xxxxxx RPM** – revolutions /speed/ of the micromotor
- **xxx,xx%**- informative output of the micromotor
- **T=xxx,xxxNcm** – set limit torque
- **R=xxx:xx** – transmission ratio
- **AFT=x,xs** - auto-forward time – displayed only in the event of the auto-forward mode (0,5;1,0;1,5;2,0;2,5;3,0;3,5;4,0)

### *Normal mode*

MX motor is controlled as standard micromotor, except that the revolutions can be set and it is possible to set the limit torque by means of the **T** symbol.

### *Auto-reverse mode*

After reaching the set limit torque, the micromotor starts to rotate in the opposite direction (counter-clockwise revolutions), namely until the foot controller has been released.

### *Auto-forward mode*

After reaching the set limit torque, the micromotor starts to rotate in the opposite direction (counter-clockwise revolutions), namely until the foot controller has been released. Then it remains in the said direction for the set time (AFT) and returns to the original revolutions (clockwise revolutions). This is repeated until the foot controller has been released.



**Note**

In the auto-forward and auto-reverse modes, the foot controller is in the ON/OFF mode. When the micromotor or turbine has been replaced in its holder, the light goes off. Always replace the micromotor or turbine in the holder only after the end of the operation (the lever of the foot controller is in the basic position). Air blowing will take place automatically for 0,5s after the activity has been finished, if cooling is activated.

**Scaler**

**Display for the scaler**

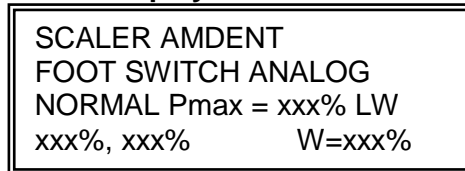

After the scaler has been taken, the data on its setting is displayed. Its meaning is as follows:

- **SCALER AMDENT** – type of the scaler taken (**SCALER SATELEC 1, SCALER SATELEC 2**)
- **FOOT SWITCH ANALOG** – analogue control of the output (**FOOT SWITCH ON/OFF** step control of the output) from the foot controller
- **NORMAL** – normal mode of activity, (**ENDO** - endo mode of activity)
- **Pmax=xxx%** - max. possible setting of the output for Amdent in ENDO mode Pmax = 33%
- **L** - instrument illumination turned on; if the symbol is not lit, the instrument illumination is turned off
- **W** – water cooling turned on; if the symbol is not lit, the cooling is turned off
- **xxx%** - set output (0 - 100%), percentage of the set output from Pmax.
- **xxx%** - output on the scaler (0 - 100%), (when the analogue control is turned on, it shows the value of the output depended on the position of the lever of the foot controller)
- **W=xxx%** - amount of cooling water (only if proportional valve is fitted)

To activate the scaler, take it and move the foot controller lever to the right. The output is set by pressing the PLUS and MINUS symbols with the instrument taken or when the scaler is in operation. ENDO function is recalled by pressing the reverse button.

When the analogue control of the output by means of the foot controller is turned on, by moving the lever of the foot controller it is possible to control the output of the scaler from 0 up to the value set on the display.

**8.2 Foot controller**

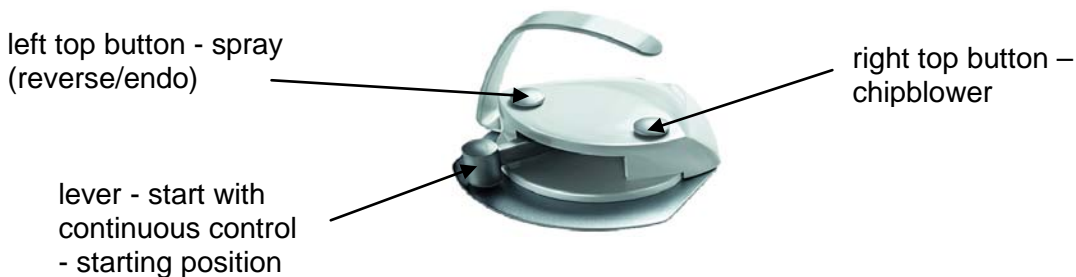

**Foot controller with continuous control**



**Foot controller UNO**

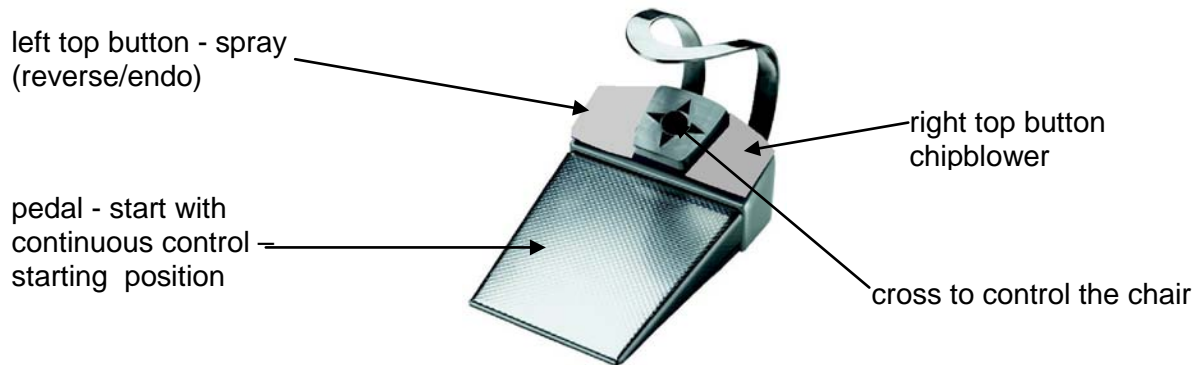

**Combined foot controller NOK**

With the micromotor and turbine instruments, when the **CHIPBLOWER** button is pressed on the foot controller, cooling air will blow.

The **SPRAY (REVERSE/ENDO)** button on the foot controller has the following **3 functions**:

1. Short by pressing the button for less than **2s**, instrument cooling is turned on/off. Information about the cooling being turned on or off is displayed. The button has a function similar to that of the **SPRAY** button on the dentist table.
2. By pressing the button for more than **2s** and less than **12s**, the direction of the revolutions of the micromotor is changed over; or when the **UOZK** scaler instrument is taken, **SCALLING/ENDO** mode alternates.
3. By pressing the button for more than **12s**, cooling modes alternate between the spray cooling mode and the water cooling mode. Selected mode is indicated on the display - "**S**" spray cooling, "**W**" water cooling.

**Foot controller lever serves** to put the instruments into operation while with the micromotor it is possible to control the micromotor speed /revolutions/ by moving the lever of the foot controller (from minimum up to the value set on the display); and with the **UOZK** scaler by moving the lever of the foot controller it is possible to control the output (from minimum up to the value set on the display).

The buttons **GETTING-ON POSITION**, **CHAIR PROGRAMMING** and **CROSS TO CONTROL THE CHAIR** are intended to control the dental chairs.

**Caution**

If no instrument is taken:

- **By keeping the lever of the foot controller** depressed for more than **0,2s** bowl flushing is activated. By keeping it depressed for more than **4s**, the bowl flushing time is set up to the moment of moving the foot controller lever to the basic position. By moving the lever of the foot controller to the right for min. **0,2s** during flushing the bowl the said activity is interrupted.
- **By pressing the CHIPBLOWER button** and keeping it depressed for **0,2s**, cup filling is activated. By keeping it depressed for more than **4s**, the cup filling time is set up to the moment of releasing the button. By pressing the right button for min. **0,2s** during filling the cup the said activity is interrupted.

When cleaning the floor (PVC floor covering) with a disinfecting agent, it is forbidden to put the foot controller onto the wet floor.

**8.3 Spittoon block**

**The spittoon block contains the following (according to the order):**

- Main switch
- Connection to the supply of mains voltage
- Connection to the supply of water and air
- Spittoon bowl flushing and cup filling
- Saliva ejector
- Connection to the distilled water
- Amalgam trap METASYS or separator CATTANI
- Mechanical amalgam trap CATTANI
- Heating of water for the cup
- Wet suction DÜRR

**Bottle with distilled water**

The bottle with distilled water is located in the spittoon block and accessible after opening the door of the spittoon block. Distilled water from the bottle is fed to the micromotor, turbine, scaler, syringe on the dentist table and syringe on the assistant table.

**How to replenish distilled water:**

- turn off the main switch - position „0“
- open the door of the spittoon block
- pull the bottle out of the internal space of the spittoon block
- unscrew the bottle
- replenish distilled water in the bottle
- screw the bottle firmly to avoid compressed air leakage during the work
- push the bottle into the internal space of the spittoon block
- turn the main switch on, position „I“
- check the bottle for air leakage
- close the door of the spittoon block

In the event that distilled water has been spent and there is air in the water distribution, it is recommended to the water paths of instruments which use water by letting water flow until there are no bubbles in the water from instruments.



**Caution**

When replenishing distilled water, care must be taken not to allow foreign substances penetrate into the water or cause changes in its quality or composition. Distilled water for medical purposes must be used, not de-mineralized water for industrial purposes!

The manufacturer recommends to replace the bottle once a year.

**Central distribution of water**

If water from the central distribution is used for cooling the instrument, distilled water in the bottle need not be replenished.







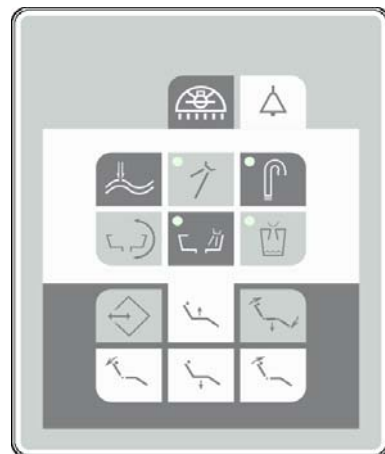





**8.3.1 Assistant table**

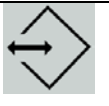

**Assistant table**

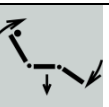

**Keyboard of the assistant table**

Symbol	Description	Symbol	Description	Symbol	Description
	button not used		control of the main light		door opening
	rotation of the spittoon bowl (in DA130, DA170 the button is not used)		button not used		button not used
	writing-in and recalling of the program positions		spittoon bowl flushing		cup filling
	switch to move the rest backward		switch to move the chair up		automatic setting of getting-on position
	switch to move the rest forward		switch to move the chair down		

Symbols on the keyboard of the assistant table have the function identical with that of the symbols on the keyboard of the dentist table.

### 8.3.2 Holder of the saliva ejector



**Double arm of the saliva ejector**

Instruments placed on the arm of the saliva ejector are ready for operation after having been taken out. Beside the saliva ejector, the polymerization lamp and the syringe can be placed on the double arm of the saliva ejector. Also there are buttons to control the cup filling and bowl flushing.

### 8.3.3 Equipment of the spittoon block

#### Saliva ejector

It is activated automatically after having been taken out of the holder. When the output is decreased, clean the saliva ejector sieve: remove the saliva ejector itself (the tip), remove the saliva ejector handpiece, remove the sieve – clean it and re-assemble. It is recommended to clean the sieve at least once a day! To finish the activity – replace it in the holder. It is recommended to rinse the saliva ejector and the aspirators with 1 dl of water after each patient!

#### Small aspirator, big aspirator

It is activated automatically after having been taken out of the holder. To finish the activity – replace it in the holder. The suction of the aspirators can be controlled by opening the regulating flap of the aspirators, while in the lower position the aspirator is closed. In the body of the aspirator is a filter which needs to be cleaned at least once a day (see the chapter 10.4).

#### Polymerization lamp

After having been taken, the polymerization lamp is ready for operation and can be used. For the use of the polymerization lamp, please read the manual for the polymerization lamp.

#### Intraoral camera

The camera does not serve to make a diagnosis but only for better visualization in the dental treatment.

#### The camera comprises:

- holder
- connection – connector
- the instrument itself (camera)



#### Caution

The product must be protected against water. Do not keep it in wet premises.

### **8.4 Dental operating light**

Dental operating light can be controlled by means of the three-position /triple-throw/ switch on the dental operating light, while in the middle position the light is turned off.

If the unit is fitted with electronic control of illumination, it is possible to control it from the dentist table and the assistant arm by means of a button – see the description of the buttons.

### **8.5 Completion of work**

**The following is important:**

- turn off the main switch – position 0! Thus disconnecting the supply of electric power, water and air and the whole unit is depressurized
- turn off /close/ the main supply of water (at the work place) to the dental unit
- turn off the compressor – open the sludge valve
- turn off the aspirator (if fitted)

## **9 PRODUCT MAINTENANCE**

Maintenance of instruments and handpieces should be carried out according to the instructions of their manufacturer. In case of the execution of the spittoon block with the connection to the central distribution water, check the cleanliness of the advance filter (strainer) and the operation of the water hardness treatment device (according to the instructions of the manufacturer).

### **Inspections during the guarantee period**

During the guarantee period the user is obliged in regular **3-month intervals** to invite authorized service technician for preventive periodical inspection.

**The inspection is focused on the following:**

- check of input filters (with regard to the cleanliness of input media)
- check of the suction system
- check of the waste hose
- providing additional information and practice advice concerning the dental unit
- check of the proper use and maintenance of the dental unit and its instruments (according to the Instructions for Use and training)
- check and/or adjustment of all media (input, setting of turbine pressures and the like)
- the manufacturer determines the range of above-mentioned work to be **1 to 1,5 hours**
- authorized service technician is obliged to confirm the periodical inspection carried out in the guarantee card.

### **Inspection and audit /revision/ after the guarantee period:**

Periodical inspection of the product must be recommended by authorized service technician in **6-month intervals, while the following is made:**

- general inspection of the dental unit and functional parts thereof
- check and adjustment of the working pressures of water and air
- check of water and air filters in the spittoon block
- check of the integrity of electropart and electric wiring (electric safety)

### **Audit /revision/ of electric safety**

It is carried out according to the regulations of the country in which the dental unit is installed.

## **10 CLEANING, DISINFECTING AND DECONTAMINATION**

### **10.1 Disinfecting of internal distributions of Instruments**

It is recommended to use Alpron agent in 1% concentration with distilled water. The solution is poured into the reservoir for distilled water and can be used permanently. The agent in 1% concentration is harmless to the health of the patient. With regular use the cooling system is maintained in cleanliness and it is not necessary to use other disinfecting agents. Alpron solution is the product of the company Alpron (Germany). Contact your dealer for details about the possibilities of the purchase and use of the said product.

In the event that water from the central distribution is used for the cooling of instruments, disinfecting of the internal distributions of the instruments is made as follows:

1. Fill the reservoir of distilled water with 1% solution of Alpron with distilled water.
2. Turn the 3-position selector switch to the position „DESTIL“.
3. Rinse the water path of an instrument for 30 s, other instruments that use cooling water are rinsed for 10s.
4. Turn the 3-position selector switch to the position „CENTRAL“.

The manufacturer recommends to carry out the above disinfecting at least once a day, preferably at the end of the working day.

### **10.2 Decontamination of the spittoon bowl**

In the event that the dental unit is equipped only with saliva ejector, 1% solution of SAVO Prim (Czech Republic) agent is used for decontamination. Disinfecting of the spittoon bowl should be made at least once a day (e.g. after the completion of work) with SAVO Prim agent in 1% concentration in the volume of at least 200ml of the solution by pouring it into the spittoon bowl.

In the event that the dental unit is equipped with an aspirator, the selection of suitable agent depends on the type of the separator that is built in the dental unit.

If CATTANI separator is built in the unit, it is necessary to use PULI - JET PLUS agent.

If METASYS amalgam trap is built in the unit, it is necessary to use GREEN & CLEAN M2 agent. If DÜRR CAS 1 amalgam trap is built in the unit, it is necessary to use OROTOL PLUS agent.

### **10.3 Cleaning and decontamination of the saliva ejector**

Decontamination of the saliva ejector should be made at least once a day (e.g. after the completion of work) with SAVO Prim agent in 1% concentration in the volume of min. 1 dcl of diluted solution by sucking through the tip of the saliva ejector. After each use of the saliva ejector, clean the hose of the saliva ejector by rinsing it with clean water of approx.1 dcl after each patient.

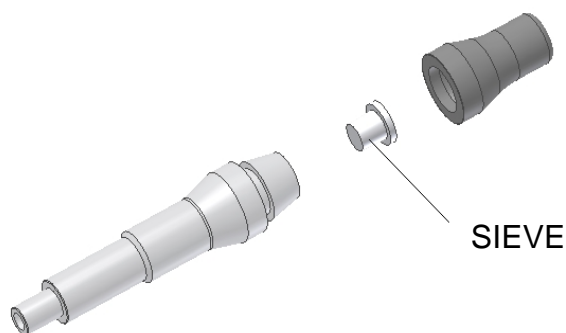



### 10.4 Cleaning and decontamination of the big and small aspirator

Operating personnel must check the condition of the sieve of the catcher of rough particles in the spittoon bowl and clean it, if needed. When the small and big aspirator or saliva ejector has been used, clean the hose thereof by rinsing it with approx. 1 dcl of clean water after each patient.

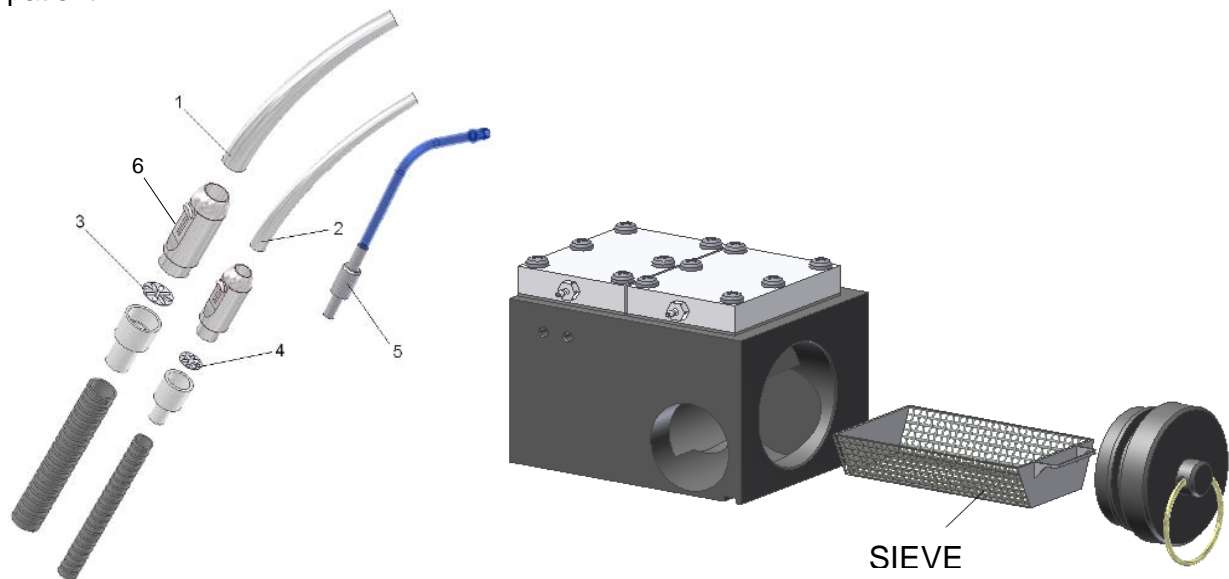

1. big aspirator
2. small aspirator
3. filter, rough P22
4. filter, rough P16
5. adapter for single-use tip for the saliva ejector
6. regulating flap of the suction

### Cleaning and disinfecting of other parts of the dental unit

Clean the external surfaces of the dental unit including the glass surface keyboard with a wet cloth. Use the INCIDIN FOAM – spray (HENKEL – ECOLAB) agent according to the instructions for use of the said agent at least once a day or when the surface of the equipment is incidentally contaminated with biological material.

**Clean the following at least once a day** (according to the version):

- aspirator sieve located in the spittoon block
- sieve at the input to the amalgam trap
- sieve of the saliva ejector, small and big aspirator
- sieve in the spittoon bowl



### Caution

When cleaning the floor (PVC floor covering) with a disinfecting agent, it is forbidden to place the foot controller onto the still wet floor covering. It is forbidden to use agents with detrimental effects on the structure of the varnish and plastic materials (agents based on phenols and aldehydes).

The manufacturer shall not be taken responsible for damages arisen due to the use of disinfecting and cleaning agents others than those recommended.

### Instruments and handpieces

Cleaning, disinfecting and sterilization of instruments and their handpieces should be carried out according to the instructions of their manufacturer, furnished with the instrument.

**Instructions for the use of disinfecting antifoam tablets CATTANI for dental aspirators**

During the work with the aspirator, turbulent flow is created when blood, mucus and all types of sanitary substances create a great amount of foam that may cause frequent and abrupt undesired stopping of suction. Each tablet is packed in a protective film that is soluble in water and ensures safety keeping and handling, even though the product is not classified as dangerous. Do not remove the protective film; it will be dissolved in water. Sucking of a small amount of water through the tip after the tablet has been placed inside the supporting filter of the tip or before starting the suction is sufficient to obtain immediate effective antifoaming effect. If the tablets are to be placed in a small space, remove the protective film (use of gloves is recommended) and break the tablet in two parts by pressing along the marked slot. As the liquid passes, the tablet will dissolve slowly and release the disinfecting and antifoaming substances during the whole working day.

**How to use the PULI - JET PLUS cleaning agent**

The separator manufacturer recommends to disinfect the suction system every day after the completion of work and to perform at least one cleansing washing in the middle of the day. How to fill the doser: place the bottle in the vertical position, preferable on a flat surface. Unscrew the lid and fill the doser to the edge by squeezing the bottle gently at the points marked with two labels (take care not to overfill it).

Release the pressure: excessive amount of the liquid returns back to the bottle while the exact amount (10ml) of the concentrate remains in the doser. Concentrated PULI – JET PLUS after dilution to 0,8% cleans and disinfects, to 0,4% it is only sanitary cleaning agent. For cleaning and disinfecting dilute two doses (20ml) of the doser in 2,5 l of warm water (50°C) and suck it. For the very cleaning of the system dilute one dose of the doser (10ml). Do not rinse, proteolytic and disinfecting effect of PULI – JET PLUS reveals with time.

**11 DISPOSAL OF THE EQUIPMENT**

Part	Basic material	Recyclable material	Material to be placed in waste dumping grounds	Dangerous material
Metal	Steel	X		
	Aluminium	X		
Plastic	PUR		X	
	PVC			X
	PA, ABS	X		
	Laminated glass		X	
	Other plastic	X		
Rubber			X	
Ceramic			X	
Instruments			X	
Electronics		X		
Cables	Copper	X		
Transformer		X		
Amalgam separator	Filters			X
	Collecting vessel with amalgam			X
Packaging	Wood	X		
	Cardboard	X		
	Paper	X		
	PUR		X	



**Note**

In the disposal of the dental unit the legislation of individual country should be observed. Before dismantling the unit, it should be decontaminated – clean the surface, rinse the suction and waste system, remove the amalgam from the trap and pass it on to a scrap material collecting organization. It is recommended to appoint the expert company with the disposal of the unit.



**Caution**

Not to be disposed of within the communal waste!!! Waste material can be handed at destined places, e.g. electrowaste!

**12 REPAIR SERVICE**

In the event of a failure of the dental unit contact the nearest service centre or your dealer who will give you information about the service network.

**13 THE CONTENTS OF THE PACKAGING**

**Standard equipment**

	<b>DA 130</b>	<b>DA 170</b>
Cap of the bearing pillar	1	
Pantograph of the control panel with the control panel	1	
Spittoon block, complete	1	
Pantograph of the light	1	
Dental operating light	1	
Foot controller	1	
Tray table	-	1
Side table (acc.to the order)	1	
Holder, lower – the light	1	
Instruments, accessories, small parts and completion sheet, sealed in a paper carton	1	

**Accompanying documentation**

- Instructions for Use
- Guarantee Card
- Inspection Card
- Manuals from subcontractors
- Completion sheet (placed in the sealed carton with the instruments)

**14 GUARANTEE**

The manufacturer gives guarantee on the product according to the guarantee card. The danger of damage on the goods passes from the seller to the buyer by the moment of passing over the goods to the first forwarding agents for the transport for the buyer or by the moment of taking over the goods directly by the buyer. The manufacturer reserves the right for changes within the innovation of the product.



**Caution**

Defects /failures/ caused by negligent operation and/or by not observing the instructions in the Instructions for Operation shall not be accepted as the subject of the claim under guarantee.

**Annex No.1 DENTAL OPERATING LIGHT SIRIUS**



**PRODUCT DESCRIPTION**

The light consists of a head and a fork. These are interconnected by means of a swivel joint. In the front part the head is fitted with a handle. It is covered with transparent plastic covers. Inside there is a bulb with a screen, which illuminates a glass reflector with special mirror surface. The supply cables are placed in the arms of the fork. The upper part of the fork serves for the connection to the light pantographic arm. In the lower part of the fork is a space for the connection of the light cables with the feeding cables, three-position switch or only feeding cables with endings in case of a version without the switch.

**VERSIONS**

According to the execution:

- with the three-position /triple-throw/ selector switch
- without the selector switch

According to the colour execution of the cover:

- semitransparent colourless
- transparent blue
- transparent green

**TECHNICAL DATA**

Supply voltage	from 10,5 V ~ to 12 V ~ (17V DC – PWM)
Power input	50 W ± 10%
Type of protection against electric shock	II
Nominal dimension of the light spot	max. 70 x 180 mm
Correlated colour temperature	4 500 – 5 500 K
Illuminance in the changing-over 10,5/12V	min. 8000 lx (pri 10,5 V) min. 20 000 lx (pri 12V)
Illuminance in the continuous regulation	in the range min. ≤ 8000 lx – max. ≥20 000 lx
Weight	1,2 ± 0,1 kg
Max. loading capacity of the handle	30 N

**BULB REPLACEMENT FOR SIRIUS LIGHT**

- loosen the screws that secure the front cover by means of hexagonal wrench /spanner/ furnished and remove the front cover

**Do not touch the bulb with hands!**

**ADJUSTMENT OF THE BRAKING FORCE IN THE SWIVEL JOINTS**

- proceed as with the replacement of the bulb
- remove the glass reflector and the bulb
- tighten the screws in the swivel joints on both sides with a wrench /spanner/
- assemble the light in the reverse order



**Caution**

It is recommended to call a service organization.

**PRODUCT OPERATION**

The operating light is set to the desired position by the handle. The switch serves to switch the operating light on and to switch over to the lower illuminance (if the switch is connected in that way). Optimum illuminance is at the distance of the operating light of 0.7 m from the patient, where also the light spot has the required shape. With the change of the distance the illuminance changes and the light spot becomes distorted.

**INSTRUCTIONS FOR MAINTENANCE**

The maintenance consists in cleaning, replacement of damaged parts and adjustment of braking force in the swivel joint. If the operating light does not turn smoothly on the pivot /pin/ of the pantograph, lubricate the pivot with silicone oil or silicone vaseline (do not use lubricants with detrimental effect on plastic material).

**CLEANING, DISINFECTING, STERILIZATION**

Clean the external surface of the operating light with a wet cotton cloth. Do not use spray. Recommended agent is INCIDIN FOAM–HENKEL–ECOLAB (Glucoprotamine, KAZ, Ethanol) according to the Instructions for use. Do not use paper towels (they contain abrasive particles).

**Caution**

When unsuitable cleaning agents are used, the plastic parts of the operating light may be damaged permanently.